

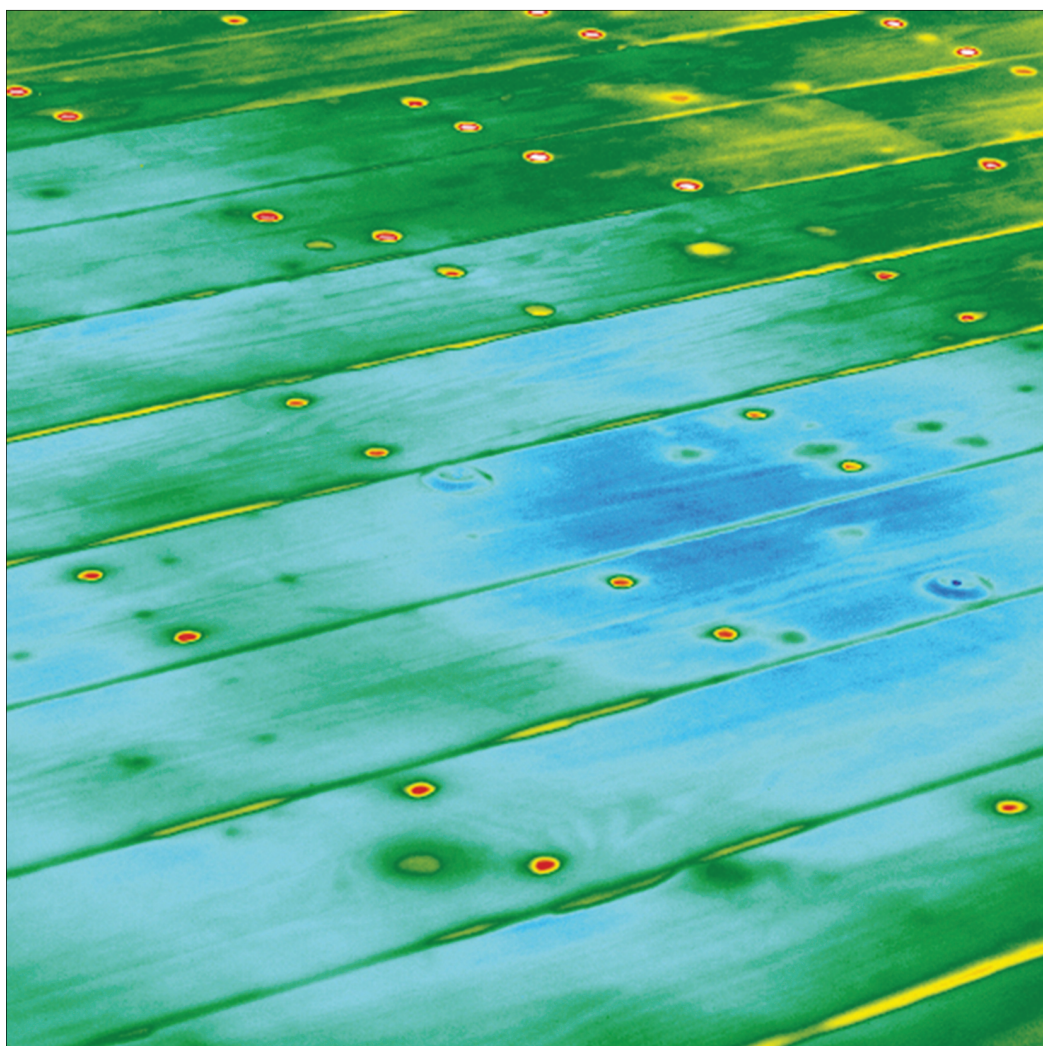

User's manual

Flir Ex series





User's manual

Flir Ex series



Table of contents

1	Legal disclaimer	1
1.1	Legal disclaimer	1
1.2	Usage statistics	1
1.3	Changes to registry	1
1.4	U.S. Government Regulations.....	2
1.5	Copyright	2
1.6	Quality assurance	2
1.7	Patents.....	2
1.8	EULA Terms	2
1.9	EULA Terms	3
2	WARNING, CAUTION	4
3	Notice to user	7
3.1	User-to-user forums	7
3.2	Calibration.....	7
3.3	Accuracy	7
3.4	Disposal of electronic waste.....	7
3.5	Training	7
3.6	Documentation updates	7
3.7	Important note about this manual.....	7
4	Customer help	8
4.1	General	8
4.2	Submitting a question	8
4.3	Downloads	8
5	Quick Start Guide	9
5.1	Procedure	9
6	Description	10
6.1	Camera parts.....	10
6.1.1	Figure.....	10
6.1.2	Explanation.....	10
6.2	Keypad.....	10
6.2.1	Figure.....	10
6.2.2	Explanation.....	10
6.3	Connectors	11
6.3.1	Figure.....	11
6.3.2	Explanation.....	11
6.4	Screen elements	12
6.4.1	Figure.....	12
6.4.2	Explanation.....	12
7	Operation	13
7.1	Charging the battery.....	13
7.1.1	Charging the battery using the Flir power supply	13
7.1.2	Charging the battery using the Flir stand-alone battery charger.....	13
7.1.3	Charging the battery using a USB cable	13
7.2	Saving an image	13
7.2.1	General.....	13
7.2.2	Image capacity	13
7.2.3	Naming convention.....	13
7.2.4	Procedure	14
7.3	Recalling an image.....	14
7.3.1	General.....	14
7.3.2	Procedure	14
7.4	Deleting an image	14
7.4.1	General.....	14

Table of contents

7.4.2	Procedure	14
7.5	Deleting all images.....	14
7.5.1	General.....	14
7.5.2	Procedure	14
7.6	Measuring a temperature using a spotmeter	15
7.6.1	General.....	15
7.6.2	Procedure	15
7.7	Measuring the hottest temperature within an area	15
7.7.1	General.....	15
7.7.2	Procedure	15
7.8	Measuring the coldest temperature within an area.....	15
7.8.1	General.....	15
7.8.2	Procedure	15
7.9	Hiding measurement tools	15
7.9.1	Procedure	15
7.10	Changing the color palette	16
7.10.1	General.....	16
7.10.2	Procedure	16
7.11	Changing image mode.....	16
7.11.1	General.....	16
7.11.2	Procedure	17
7.12	Changing the temperature scale mode	17
7.12.1	General.....	17
7.12.2	When to use <i>Lock</i> mode	17
7.12.3	Procedure	18
7.13	Setting the emissivity as a surface property	18
7.13.1	General.....	18
7.13.2	Procedure	18
7.14	Setting the emissivity as a custom material.....	18
7.14.1	General.....	18
7.14.2	Procedure	18
7.15	Changing the emissivity as a custom value	19
7.15.1	General.....	19
7.15.2	Procedure	19
7.16	Changing the reflected apparent temperature	19
7.16.1	General.....	19
7.16.2	Procedure	19
7.17	Changing the settings.....	19
7.17.1	General.....	19
7.17.2	Procedure	20
7.18	Updating the camera	20
7.18.1	General.....	20
7.18.2	Procedure	20
8	Technical data.....	21
9	Cleaning the camera	22
9.1	Camera housing, cables, and other items.....	22
9.1.1	Liquids.....	22
9.1.2	Equipment.....	22
9.1.3	Procedure	22
9.2	Infrared lens	22
9.2.1	Liquids.....	22
9.2.2	Equipment.....	22
9.2.3	Procedure	22
10	Application examples.....	23
10.1	Moisture & water damage	23

Table of contents

	10.1.1 General.....	23
	10.1.2 Figure.....	23
10.2	Faulty contact in socket.....	23
	10.2.1 General.....	23
	10.2.2 Figure.....	23
10.3	Oxidized socket.....	24
	10.3.1 General.....	24
	10.3.2 Figure.....	24
10.4	Insulation deficiencies.....	25
	10.4.1 General.....	25
	10.4.2 Figure.....	25
10.5	Draft	26
	10.5.1 General.....	26
	10.5.2 Figure.....	26
11	About Flir Systems	27
	11.1 More than just an infrared camera	28
	11.2 Sharing our knowledge	28
	11.3 Supporting our customers.....	28
	11.4 A few images from our facilities	29
12	Glossary	30
13	Thermographic measurement techniques	33
	13.1 Introduction	33
	13.2 Emissivity.....	33
	13.2.1 Finding the emissivity of a sample	33
	13.3 Reflected apparent temperature.....	36
	13.4 Distance	36
	13.5 Relative humidity	36
	13.6 Other parameters.....	36
14	History of infrared technology.....	38
15	Theory of thermography.....	41
	15.1 Introduction	41
	15.2 The electromagnetic spectrum.....	41
	15.3 Blackbody radiation.....	41
	15.3.1 Planck's law	42
	15.3.2 Wien's displacement law.....	43
	15.3.3 Stefan-Boltzmann's law	44
	15.3.4 Non-blackbody emitters.....	45
	15.4 Infrared semi-transparent materials.....	47
16	The measurement formula.....	48
17	Emissivity tables	52
	17.1 References.....	52
	17.2 Tables	52

Legal disclaimer

1.1 Legal disclaimer

All products manufactured by Flir Systems are warranted against defective materials and workmanship for a period of one (1) year from the delivery date of the original purchase, provided such products have been under normal storage, use and service, and in accordance with Flir Systems instruction.

Uncooled handheld infrared cameras manufactured by Flir Systems are warranted against defective materials and workmanship for a period of two (2) years from the delivery date of the original purchase, provided such products have been under normal storage, use and service, and in accordance with Flir Systems instruction, and provided that the camera has been registered within 60 days of original purchase.

Detectors for uncooled handheld infrared cameras manufactured by Flir Systems are warranted against defective materials and workmanship for a period of ten (10) years from the delivery date of the original purchase, provided such products have been under normal storage, use and service, and in accordance with Flir Systems instruction, and provided that the camera has been registered within 60 days of original purchase.

Products which are not manufactured by Flir Systems but included in systems delivered by Flir Systems to the original purchaser, carry the warranty, if any, of the particular supplier only. Flir Systems has no responsibility whatsoever for such products.

The warranty extends only to the original purchaser and is not transferable. It is not applicable to any product which has been subjected to misuse, neglect, accident or abnormal conditions of operation. Expendable parts are excluded from the warranty.

In the case of a defect in a product covered by this warranty the product must not be further used in order to prevent additional damage. The purchaser shall promptly report any defect to Flir Systems or this warranty will not apply.

Flir Systems will, at its option, repair or replace any such defective product free of charge if, upon inspection, it proves to be defective in material or workmanship and provided that it is returned to Flir Systems within the said one-year period.

Flir Systems has no other obligation or liability for defects than those set forth above.

No other warranty is expressed or implied. Flir Systems specifically disclaims the implied warranties of merchantability and fitness for a particular purpose.

Flir Systems shall not be liable for any direct, indirect, special, incidental or consequential loss or damage, whether based on contract, tort or any other legal theory.

This warranty shall be governed by Swedish law.

Any dispute, controversy or claim arising out of or in connection with this warranty, shall be finally settled by arbitration in accordance with the Rules of the Arbitration Institute of the Stockholm Chamber of Commerce. The place of arbitration shall be Stockholm. The language to be used in the arbitral proceedings shall be English.

1.2 Usage statistics

Flir Systems reserves the right to gather anonymous usage statistics to help maintain and improve the quality of our software and services.

1.3 Changes to registry

The registry entry HKEY_LOCAL_MACHINE\SYSTEM\CurrentControlSet\Control\Lsa\LmCompatibilityLevel will be automatically changed to level 2 if the Flir Camera Monitor service detects a Flir camera connected to the computer with a USB cable. The modification will only be executed if the camera device implements a remote network service that supports network logons.

1.4 U.S. Government Regulations

This product is subject to US Export Regulations. Please refer to exportquestions@flir.com with any questions.

1.5 Copyright

© 2013, Flir Systems, Inc. All rights reserved worldwide. No parts of the software including source code may be reproduced, transmitted, transcribed or translated into any language or computer language in any form or by any means, electronic, magnetic, optical, manual or otherwise, without the prior written permission of Flir Systems.

The documentation must not, in whole or part, be copied, photocopied, reproduced, translated or transmitted to any electronic medium or machine readable form without prior consent, in writing, from Flir Systems.

Names and marks appearing on the products herein are either registered trademarks or trademarks of Flir Systems and/or its subsidiaries. All other trademarks, trade names or company names referenced herein are used for identification only and are the property of their respective owners.

1.6 Quality assurance

The Quality Management System under which these products are developed and manufactured has been certified in accordance with the ISO 9001 standard.

Flir Systems is committed to a policy of continuous development; therefore we reserve the right to make changes and improvements on any of the products without prior notice.

1.7 Patents

One or several of the following patents or design patents may apply to the products and/or features:

0002258-2; 000279476-0001; 000439161; 000499579-0001; 000653423; 000726344; 000859020; 001106306-0001; 001707738; 001707746; 001707787; 001776519; 001954074; 002021543; 002058180-001; 0101577-5; 0102150-0; 1144833; 1182246; 1182620; 1285345; 1299699; 1325808; 1336775; 1391114; 1402918; 1404291; 1411581; 1415075; 1421497; 1458284; 1678485; 1732314; 2106017; 2381417; 3006596; 3006597; 466540; 483782; 484155; 4889913; 60122153.2; 602004011681.5-08; 6707044; 68657; 7034300; 7110035; 7154093; 7157705; 7237946; 7312822; 7332716; 7336823; 7544944; 7667198; 7809258; 7826736; 8,018,649 B2; 8,153,971; 8212210 B2; 8289372; 8354639 B2; 8384783; D540838; D549758; D579475; D584755; D599,392; D615,113; D664,580; D664,581; D665,004; D665,440; D16702302-9; D16803572-1; D16903617-9; D17002221-6; D17002891-5; D17002892-3; D17005799-0; DM/057692; DM/061609; ZL01823221.3; ZL01823226.4; ZL02331553.9; ZL02331554.7; ZL200480034894.0; ZL200530120994.2; ZL200610088759.5; ZL200630130114.4; ZL200730151141.4; ZL200730339504.7; ZL200820105768.8; ZL200830128581.2; ZL200880105769.2; ZL200930190061.9; ZL201030176127.1; ZL201030176130.3; ZL201030176157.2; ZL201030595931.3; ZL201130442354.9.

1.8 EULA Terms

- You have acquired a device (“INFRARED CAMERA”) that includes software licensed by Flir Systems AB from Microsoft Licensing, GP or its affiliates (“MS”). Those installed software products of MS origin, as well as associated media, printed materials, and “online” or electronic documentation (“SOFTWARE”) are protected by international intellectual property laws and treaties. The SOFTWARE is licensed, not sold. All rights reserved.
- IF YOU DO NOT AGREE TO THIS END USER LICENSE AGREEMENT (“EULA”), DO NOT USE THE DEVICE OR COPY THE SOFTWARE. INSTEAD, PROMPTLY CONTACT Flir Systems AB FOR INSTRUCTIONS ON RETURN OF THE UNUSED DEVICE(S) FOR A REFUND. **ANY USE OF THE SOFTWARE, INCLUDING BUT NOT LIMITED TO USE ON THE DEVICE, WILL CONSTITUTE YOUR AGREEMENT TO THIS EULA (OR RATIFICATION OF ANY PREVIOUS CONSENT).**

-
- **GRANT OF SOFTWARE LICENSE.** This EULA grants you the following license:
 - You may use the SOFTWARE only on the DEVICE.
 - **NOT FAULT TOLERANT.** THE SOFTWARE IS NOT FAULT TOLERANT. Flir Systems AB HAS INDEPENDENTLY DETERMINED HOW TO USE THE SOFTWARE IN THE DEVICE, AND MS HAS RELIED UPON Flir Systems AB TO CONDUCT SUFFICIENT TESTING TO DETERMINE THAT THE SOFTWARE IS SUITABLE FOR SUCH USE.
 - **NO WARRANTIES FOR THE SOFTWARE.** THE SOFTWARE is provided “AS IS” and with all faults. THE ENTIRE RISK AS TO SATISFACTORY QUALITY, PERFORMANCE, ACCURACY, AND EFFORT (INCLUDING LACK OF NEGLIGENCE) IS WITH YOU. ALSO, THERE IS NO WARRANTY AGAINST INTERFERENCE WITH YOUR ENJOYMENT OF THE SOFTWARE OR AGAINST INFRINGEMENT. **IF YOU HAVE RECEIVED ANY WARRANTIES REGARDING THE DEVICE OR THE SOFTWARE, THOSE WARRANTIES DO NOT ORIGINATE FROM, AND ARE NOT BINDING ON, MS.**
 - No Liability for Certain Damages. **EXCEPT AS PROHIBITED BY LAW, MS SHALL HAVE NO LIABILITY FOR ANY INDIRECT, SPECIAL, CONSEQUENTIAL OR INCIDENTAL DAMAGES ARISING FROM OR IN CONNECTION WITH THE USE OR PERFORMANCE OF THE SOFTWARE. THIS LIMITATION SHALL APPLY EVEN IF ANY REMEDY FAILS OF ITS ESSENTIAL PURPOSE. IN NO EVENT SHALL MS BE LIABLE FOR ANY AMOUNT IN EXCESS OF U.S. TWO HUNDRED FIFTY DOLLARS (U.S.\$250.00).**
 - **Limitations on Reverse Engineering, Decompilation, and Disassembly.** You may not reverse engineer, decompile, or disassemble the SOFTWARE, except and only to the extent that such activity is expressly permitted by applicable law notwithstanding this limitation.
 - **SOFTWARE TRANSFER ALLOWED BUT WITH RESTRICTIONS.** You may permanently transfer rights under this EULA only as part of a permanent sale or transfer of the Device, and only if the recipient agrees to this EULA. If the SOFTWARE is an upgrade, any transfer must also include all prior versions of the SOFTWARE.
 - **EXPORT RESTRICTIONS.** You acknowledge that SOFTWARE is subject to U.S. export jurisdiction. You agree to comply with all applicable international and national laws that apply to the SOFTWARE, including the U.S. Export Administration Regulations, as well as end-user, end-use and destination restrictions issued by U.S. and other governments. For additional information see <http://www.microsoft.com/exporting/>.

1.9 EULA Terms

Qt4 Core and Qt4 GUI, Copyright ©2013 Nokia Corporation and FLIR Systems AB. This Qt library is a free software; you can redistribute it and/or modify it under the terms of the GNU Lesser General Public License as published by the Free Software Foundation; either version 2.1 of the License, or (at your option) any later version. This library is distributed in the hope that it will be useful, but WITHOUT ANY WARRANTY; without even the implied warranty of MERCHANTABILITY or FITNESS FOR A PARTICULAR PURPOSE. See the GNU Lesser General Public License, <http://www.gnu.org/licenses/lgpl-2.1.html>. The source code for the libraries Qt4 Core and Qt4 GUI may be requested from FLIR Systems AB.

WARNING, CAUTION



WARNING

Applicability: Cameras with one or several batteries.

Do not disassemble or do a modification to the battery. The battery contains safety and protection devices which, if they become damaged, can cause the battery to become hot, or cause an explosion or an ignition.



WARNING

Applicability: Cameras with one or several batteries.

If there is a leak from the battery and the fluid gets into your eyes, do not rub your eyes. Flush well with water and immediately get medical care. The battery fluid can cause injury to your eyes if you do not do this.



WARNING

Applicability: Cameras with one or several batteries.

Do not continue to charge the battery if it does not become charged in the specified charging time. If you continue to charge the battery, it can become hot and cause an explosion or ignition.



WARNING

Applicability: Cameras with one or several batteries.

Only use the correct equipment to discharge the battery. If you do not use the correct equipment, you can decrease the performance or the life cycle of the battery. If you do not use the correct equipment, an incorrect flow of current to the battery can occur. This can cause the battery to become hot, or cause an explosion and injury to persons.



WARNING

Make sure that you read all applicable MSDS (Material Safety Data Sheets) and warning labels on containers before you use a liquid: the liquids can be dangerous.



CAUTION

Do not point the infrared camera (with or without the lens cover) at intensive energy sources, for example devices that emit laser radiation, or the sun. This can have an unwanted effect on the accuracy of the camera. It can also cause damage to the detector in the camera.



CAUTION

Do not use the camera in a temperature higher than +50°C (+122°F), unless specified otherwise in the user documentation or technical data. High temperatures can cause damage to the camera.



CAUTION

Applicability: Cameras with one or several batteries.

Do not attach the batteries directly to a car's cigarette lighter socket, unless a specific adapter for connecting the batteries to a cigarette lighter socket is provided by Flir Systems.



CAUTION

Applicability: Cameras with one or several batteries.

Do not connect the positive terminal and the negative terminal of the battery to each other with a metal object (such as wire).



CAUTION

Applicability: Cameras with one or several batteries.

Do not get water or salt water on the battery, or permit the battery to get wet.

**CAUTION**

Applicability: Cameras with one or several batteries.

Do not make holes in the battery with objects. Do not hit the battery with a hammer. Do not step on the battery, or apply strong impacts or shocks to it.

**CAUTION**

Applicability: Cameras with one or several batteries.

Do not put the batteries in or near a fire, or into direct sunlight. When the battery becomes hot, the built-in safety equipment becomes energized and can stop the battery charging process. If the battery becomes hot, damage can occur to the safety equipment and this can cause more heat, damage or ignition of the battery.

**CAUTION**

Applicability: Cameras with one or several batteries.

Do not put the battery on a fire or increase the temperature of the battery with heat.

**CAUTION**

Applicability: Cameras with one or several batteries.

Do not put the battery on or near fires, stoves, or other high-temperature locations.

**CAUTION**

Applicability: Cameras with one or several batteries.

Do not solder directly onto the battery.

**CAUTION**

Applicability: Cameras with one or several batteries.

Do not use the battery if, when you use, charge, or store the battery, there is an unusual smell from the battery, the battery feels hot, changes color, changes shape, or is in an unusual condition. Contact your sales office if one or more of these problems occurs.

**CAUTION**

Applicability: Cameras with one or several batteries.

Only use a specified battery charger when you charge the battery.

**CAUTION**







Applicability: Cameras with one or several batteries.

The temperature range through which you can charge the battery is $\pm 0^{\circ}\text{C}$ to $+45^{\circ}\text{C}$ ($+32^{\circ}\text{F}$ to $+113^{\circ}\text{F}$), unless specified otherwise in the user documentation or technical data. If you charge the battery at temperatures out of this range, it can cause the battery to become hot or to break. It can also decrease the performance or the life cycle of the battery.

**CAUTION**

Applicability: Cameras with one or several batteries.

The temperature range through which you can discharge the battery is -15°C to $+50^{\circ}\text{C}$ ($+5^{\circ}\text{F}$ to $+122^{\circ}\text{F}$), unless specified otherwise in the user documentation or technical data. Use of the battery out of this temperature range can decrease the performance or the life cycle of the battery.

 CAUTION
Applicability: Cameras with one or several batteries. When the battery is worn, apply insulation to the terminals with adhesive tape or similar materials before you discard it.
 CAUTION
Applicability: Cameras with one or several batteries. Remove any water or moisture on the battery before you install it.
 CAUTION
Do not apply solvents or similar liquids to the camera, the cables, or other items. This can cause damage.
 CAUTION
Be careful when you clean the infrared lens. The lens has a delicate anti-reflective coating.
 CAUTION
Do not clean the infrared lens too vigorously. This can damage the anti-reflective coating.
 CAUTION
The encapsulation rating is valid only when all openings on the camera are sealed with their designated covers, hatches, or caps. This includes, but is not limited to, compartments for data storage, batteries, and connectors.

3.1 User-to-user forums

Exchange ideas, problems, and infrared solutions with fellow thermographers around the world in our user-to-user forums. To go to the forums, visit:

<http://www.infraredtraining.com/community/boards/>

3.2 Calibration

We recommend that you send in the camera for calibration once a year. Contact your local sales office for instructions on where to send the camera.

3.3 Accuracy

For very accurate results, we recommend that you wait 5 minutes after you have started the camera before measuring a temperature.

3.4 Disposal of electronic waste



As with most electronic products, this equipment must be disposed of in an environmentally friendly way, and in accordance with existing regulations for electronic waste.

Please contact your Flir Systems representative for more details.

3.5 Training

To read about infrared training, visit:

- <http://www.infraredtraining.com>
- <http://www.irtraining.com>
- <http://www.irtraining.eu>

3.6 Documentation updates

Our manuals are updated several times per year, and we also issue product-critical notifications of changes on a regular basis.

To access the latest manuals and notifications, go to the Download tab at:

<http://support.flir.com>

It only takes a few minutes to register online. In the download area you will also find the latest releases of manuals for our other products, as well as manuals for our historical and obsolete products.

3.7 Important note about this manual

Flir Systems issues generic manuals that cover several cameras within a model line.

This means that this manual may contain descriptions and explanations that do not apply to your particular camera model.

FLIR Customer Support Center

Home | Answers | Ask a Question | Product Registration | Downloads | My Stuff | Service

FLIR Customer support

Get the most out of your FLIR products

Get Support for Your FLIR Products

Welcome to the FLIR Customer Support Center. This portal will help you as a FLIR customer to get the most out of your FLIR products. The portal gives you access to:

- The FLIR Knowledgebase
- Ask our support team (requires registration)
- Software and documentation (requires registration)
- FLIR service contacts

Find Answers

We store all resolved problems in our solution database. Search by product, category, keywords, or phrases.

Search by Keyword

[Search All Answers](#)

[See All Popular Answers](#)

4.1 General

For customer help, visit:

<http://support.flir.com>

4.2 Submitting a question

To submit a question to the customer help team, you must be a registered user. It only takes a few minutes to register online. If you only want to search the knowledgebase for existing questions and answers, you do not need to be a registered user.

When you want to submit a question, make sure that you have the following information to hand:

- The camera model
- The camera serial number
- The communication protocol, or method, between the camera and your device (for example, HDMI, Ethernet, USB, or FireWire)
- Device type (PC/Mac/iPhone/iPad/Android device, etc.)
- Version of any programs from Flir Systems
- Full name, publication number, and revision number of the manual

4.3 Downloads

On the customer help site you can also download the following:

- Firmware updates for your infrared camera.
- Program updates for your PC/Mac software.
- Freeware and evaluation versions of PC/Mac software.
- User documentation for current, obsolete, and historical products.
- Mechanical drawings (in *.dxf and *.pdf format).
- Cad data models (in *.stp format).
- Application stories.
- Technical datasheets.
- Product catalogs.

5.1 Procedure

Follow this procedure:

1. Charge the battery. You can do this in three different ways:
 - Charge the battery using the Flir stand-alone battery charger.
 - Charge the battery using the Flir power supply.
 - Charge the battery using a USB cable connected to a computer.

Note

Charging the camera using a USB cable connected to a computer takes *considerably* longer than using the Flir power supply or the Flir stand-alone battery charger.

2. Push the On/off button  to turn on the camera.
3. Open the lens cap by pushing the lens cap lever.
4. Aim the camera toward your target of interest.
5. Pull the trigger to save an image.

(Optional steps)

6. Install Flir Tools on your computer.
7. Start Flir Tools.
8. Connect the camera to your computer, using the USB cable.
9. Import the images into Flir Tools.
10. Create a PDF report in Flir Tools.

6.1 Camera parts

6.1.1 Figure

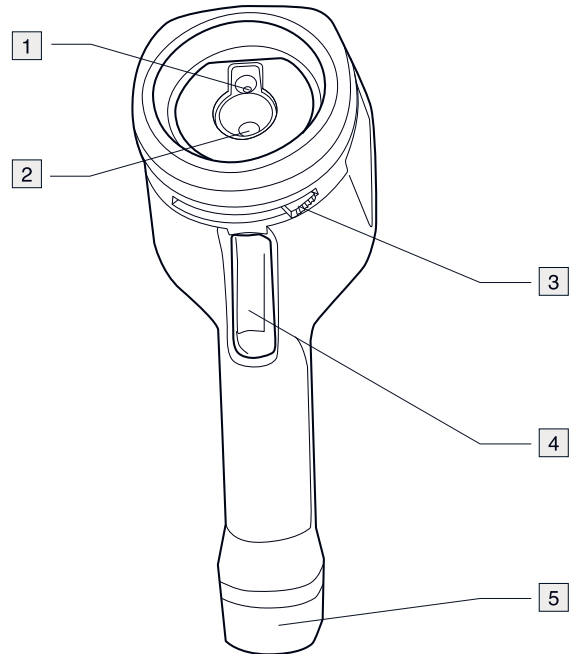

6.1.2 Explanation

1. Digital camera lens.
2. Infrared lens.
3. Lever to open and close the lens cap.
4. Trigger to save images.
5. Battery.

6.2 Keypad

6.2.1 Figure

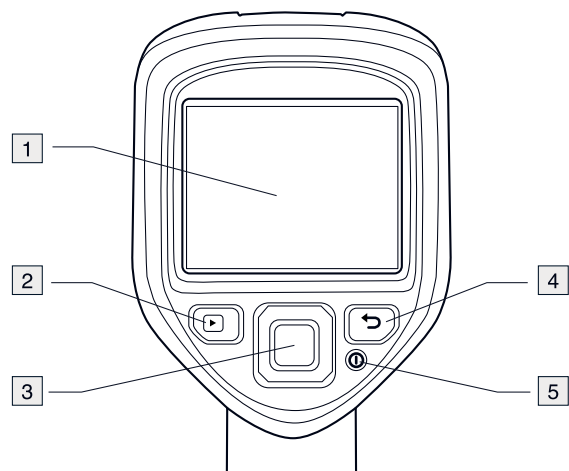

6.2.2 Explanation

1. Camera screen.

2. Archive button .

Function:

- Push to open the image archive.

3. Navigation pad.

Function:

- Push left/right or up/down to navigate in menus, submenus, and dialog boxes.
- Push the center to confirm.

4. Cancel button .

Function:

- Push to cancel a choice.
- Push to go back into the menu system.

5. On/off button .

Function:

- Push to turn on the camera.
- Push and hold for more than 1 second to turn off the camera.

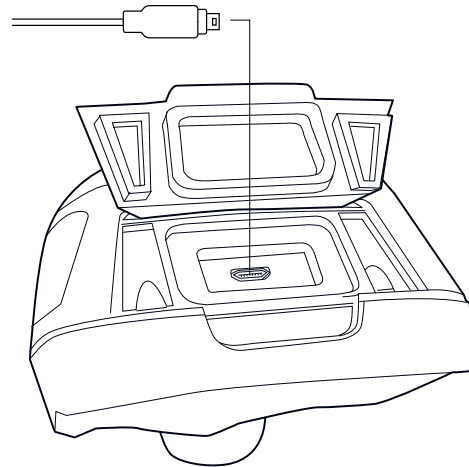
6.3 Connectors**6.3.1 Figure****6.3.2 Explanation**

The purpose of this USB mini-B connector is the following:

- Charging the battery using the Flir power supply.
- Charging the battery using a USB cable connected to a computer.

Note

Charging the camera using a USB cable connected to a computer takes *considerably* longer than using the Flir power supply or the Flir stand-alone battery charger.

- Moving images from the camera to a computer for further analysis in Flir Tools.

Note

Install Flir Tools on your computer before you move the images.

6.4 Screen elements

6.4.1 Figure

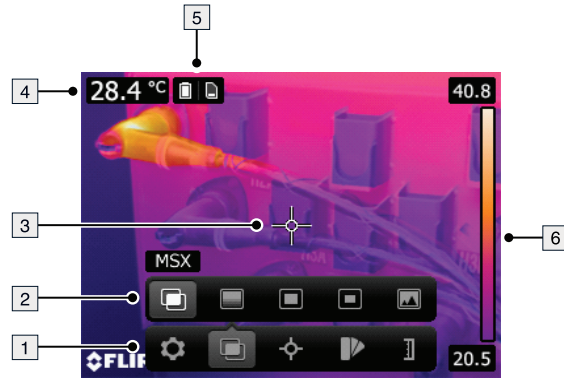

6.4.2 Explanation

1. Main menu toolbar.
2. Submenu toolbar.
3. Spotmeter.
4. Result table.
5. Status icons.
6. Temperature scale.

7.1 Charging the battery

7.1.1 Charging the battery using the Flir power supply

Follow this procedure:

1. Connect the power supply to a wall outlet.
2. Connect the power supply cable to the USB connector on the camera.

Note

The charging time for a fully depleted battery is 2 hours.

7.1.2 Charging the battery using the Flir stand-alone battery charger.

Follow this procedure:

1. Connect the stand-alone battery charger to a wall outlet.
2. Remove the battery from the camera.

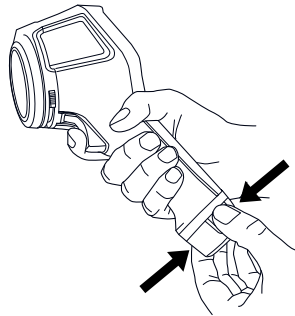

3. Put the battery into the stand-alone battery charger.

Note

- The charging time for a fully depleted battery is 2 hours.
- The battery is being charged when the blue LED is flashing.
- The battery is fully charged when the blue LED is continuous.

7.1.3 Charging the battery using a USB cable

Follow this procedure:

1. Connect the camera to a computer using a USB cable.

Note

- To charge the camera, the computer must be turned on.
- Charging the camera using a USB cable connected to a computer takes *considerably* longer than using the Flir power supply or the Flir stand-alone battery charger.

7.2 Saving an image

7.2.1 General

You can save multiple images to the internal camera memory.

7.2.2 Image capacity

Approximately 500 images can be saved to the internal camera memory.

7.2.3 Naming convention

The naming convention for images is *FLIRxxxx.jpg*, where *xxxx* is a unique counter.

7.2.4 Procedure

Follow this procedure:

1. To save an image, pull the trigger.

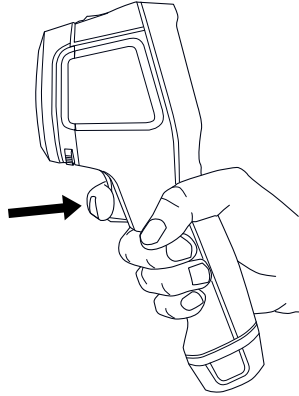



7.3 Recalling an image

7.3.1 General

When you save an image, it is stored in the internal camera memory. To display the image again, you can recall it from the internal camera memory.

7.3.2 Procedure

Follow this procedure:

1. Push the Archive button .
2. Push the navigation pad left/right or up/down to select the image you want to view.
3. Push the center of the navigation pad. This displays the selected image.
4. To return to live mode, push the Cancel button  repeatedly or push the Archive button .



7.4 Deleting an image

7.4.1 General

You can delete one or more images from the internal camera memory.

7.4.2 Procedure

Follow this procedure:

1. Push the Archive button .
2. Push the navigation pad left/right or up/down to select the image you want to view.
3. Push the center of the navigation pad. This displays the selected image.
4. Push the center of the navigation pad. This displays a toolbar.
5. On the toolbar, select *Delete* .

7.5 Deleting all images

7.5.1 General

You can delete all images from the internal camera memory.

7.5.2 Procedure

Follow this procedure:

1. Push the center of the navigation pad. This displays a toolbar.

2. On the toolbar, select *Settings* . This displays a dialog box.
3. In the dialog box, select *Device settings*. This displays a dialog box.
4. In the dialog box, select *Reset options*. This displays a dialog box.
5. In the dialog box, select *Delete all saved images*.



7.6 Measuring a temperature using a spotmeter

7.6.1 General

You can measure a temperature using a spotmeter. This will display the temperature at the position of the spotmeter on the screen.

7.6.2 Procedure

Follow this procedure:

1. Push the center of the navigation pad. This displays a toolbar.
2. On the toolbar, select *Measurement* . This displays a toolbar.
3. On the toolbar, select *Center spot* .
The temperature at the position of the spotmeter will now be displayed in the top left corner of the screen.



7.7 Measuring the hottest temperature within an area

7.7.1 General

You can measure the hottest temperature within an area. This displays a moving spotmeter that indicates the hottest temperature.

7.7.2 Procedure

Follow this procedure:

1. Push the center of the navigation pad. This displays a toolbar.
2. On the toolbar, select *Measurement* . This displays a toolbar.
3. On the toolbar, select *Auto hot spot* .



7.8 Measuring the coldest temperature within an area

7.8.1 General

You can measure the coldest temperature within an area. This displays a moving spotmeter that indicates the coldest temperature.

7.8.2 Procedure



Follow this procedure:

1. Push the center of the navigation pad. This displays a toolbar.
2. On the toolbar, select *Measurement* . This displays a toolbar.
3. On the toolbar, select *Auto cold spot* .

7.9 Hiding measurement tools

7.9.1 Procedure

Follow this procedure:

1. Push the center of the navigation pad. This displays a toolbar.
2. On the toolbar, select *Measurement* . This displays a toolbar.
3. On the toolbar, select *No measurements* .

7.10 Changing the color palette

7.10.1 General

You can change the color palette that the camera uses to display different temperatures. A different palette can make it easier to analyze an image.

7.10.2 Procedure

Follow this procedure:

1. Push the center of the navigation pad. This displays a toolbar.
2. On the toolbar, select *Color* . This displays a toolbar.
3. On the toolbar, select a new color palette.

7.11 Changing image mode

7.11.1 General

The camera can operate in five different image modes:

- *MSX* (Multi Spectral Dynamic Imaging): The camera displays an infrared image where the edges of the objects are enhanced.



- *Thermal*: The camera displays a fully thermal image.



- *Picture-in-picture* (large): The camera displays a digital camera image with a large superimposed infrared image frame.



- *Picture-in-picture* (small): The camera displays a digital camera image with a small superimposed infrared image frame.

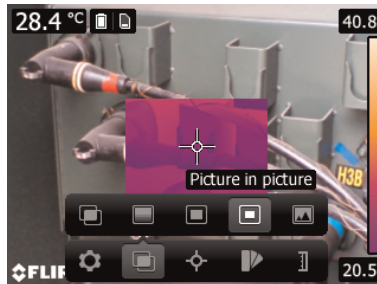







- *Digital camera*: The camera displays a digital camera image.



7.11.2 Procedure

Follow this procedure:

1. Push the center of the navigation pad. This displays a toolbar.
2. On the toolbar, select *Image mode* . This displays a toolbar.
3. On the toolbar, select one of the following:
 - *MSX* .
 - *Thermal* .
 - *Picture-in-picture* (large) .
 - *Picture-in-picture* (small) .
 - *Digital camera* .

7.12 Changing the temperature scale mode

7.12.1 General

The camera can operate in two different temperature scale modes:

- *Auto* mode: In this mode, the camera is continuously auto-adjusted for the best image brightness and contrast.
- *Lock* mode: In this mode, the camera locks the temperature span and the temperature level.

7.12.2 When to use Lock mode



A typical situation where you would want to use *Lock* mode is when looking for temperature anomalies in two items with a similar design or construction.

For example, if you are looking at two cables, where you suspect one is overheated, working in *Lock* mode will clearly show that one is overheated. The higher temperature in that cable would create a *lighter* color for the *higher* temperature.

If you use *Auto* mode instead, the color for the two items will appear the same.

7.12.3 Procedure

Follow this procedure:

1. Push the center of the navigation pad. This displays a toolbar.
2. On the toolbar, select *Temperature scale* . This displays a toolbar.
3. On the toolbar, select one of the following:
 - *Auto* 
 - *Lock* 

7.13 Setting the emissivity as a surface property

7.13.1 General

To measure temperatures accurately, the camera must know what kind of surface you are measuring. You can choose between the following surface properties:

- *Matt.*
- *Semi-matt.*
- *Semi-glossy.*

For more information about emissivity, see section 13 *Thermographic measurement techniques*, page 33.

7.13.2 Procedure

Follow this procedure:

1. Push the center of the navigation pad. This displays a toolbar.
2. On the toolbar, select *Settings* . This displays a dialog box.
3. In the dialog box, select *Measurement parameters*. This displays a dialog box.
4. In the dialog box, select *Emissivity*. This displays a dialog box.
5. In the dialog box, select one of the following:
 - *Matt.*
 - *Semi-matt.*
 - *Semi-glossy.*

7.14 Setting the emissivity as a custom material

7.14.1 General

Instead of specifying a surface property as matt, semi-matt or semi-glossy, you can specify a custom material from a list of materials.

For more information about emissivity, see section 13 *Thermographic measurement techniques*, page 33.

7.14.2 Procedure

Follow this procedure:

1. Push the center of the navigation pad. This displays a toolbar.
2. On the toolbar, select *Settings* . This displays a dialog box.
3. In the dialog box, select *Measurement parameters*. This displays a dialog box.
4. In the dialog box, select *Emissivity*. This displays a dialog box.
5. In the dialog box, select *Custom material*. This displays a list of materials with known emissivities.
6. In the list, select the material.

7.15 Changing the emissivity as a custom value

7.15.1 General

For very precise measurements, you may need to set the emissivity, instead of selecting a surface property or a custom material. You also need to understand how emissivity and reflectivity affect measurements, rather than just simply selecting a surface property.

Emissivity is a property that indicates how much radiation originates from an object as opposed to being reflected by it. A lower value indicates that a larger proportion is being reflected, while a high value indicates that a lower proportion is being reflected.

Polished stainless steel, for example, has an emissivity of 0.14, while a structured PVC floor typically has an emissivity of 0.93.

For more information about emissivity, see section 13 *Thermographic measurement techniques*, page 33.

7.15.2 Procedure

Follow this procedure:

1. Push the center of the navigation pad. This displays a toolbar.
2. On the toolbar, select *Settings* . This displays a dialog box.
3. In the dialog box, select *Measurement parameters*. This displays a dialog box.
4. In the dialog box, select *Emissivity*. This displays a dialog box.
5. In the dialog box, select *Custom value*. This displays a dialog box where you can set a custom value.

7.16 Changing the reflected apparent temperature

7.16.1 General

This parameter is used to compensate for the radiation reflected by the object. If the emissivity is low and the object temperature significantly different from that of the reflected temperature, it will be important to set and compensate for the reflected apparent temperature correctly.

For more information about reflected apparent temperature, see section 13 *Thermographic measurement techniques*, page 33.

7.16.2 Procedure

Follow this procedure:

1. Push the center of the navigation pad. This displays a toolbar.
2. On the toolbar, select *Settings* . This displays a dialog box.
3. In the dialog box, select *Measurement parameters*. This displays a dialog box.
4. In the dialog box, select *Reflected apparent temperature*. This displays a dialog box where you can set a value.

7.17 Changing the settings

7.17.1 General

You can change a variety of settings for the camera. These include the following:

- *Region & time:*
 - *Language.*
 - *Temperature unit.*
 - *Date & time.*
 - *Date & time format.*

- *Reset options:*
 - *Reset default camera mode.*
 - *Reset device settings to factory default.*
 - *Delete all saved images.*
- *Power:*
 - *Auto power off.*
 - *Display intensity.*
- *Photo as separate JPEG:* When this menu command is selected, the digital photo from the visual camera is saved at its full field of view as a separate JPEG image.
- *Camera information:* This menu command displays various items of information about the camera, such as the model, serial number, software version, latest calibration date, etc.

7.17.2 Procedure

Follow this procedure:

1. Push the center of the navigation pad. This displays a toolbar.
2. On the toolbar, select *Settings* . This displays a dialog box.
3. In the dialog box, select *Device settings*. This displays a dialog box.
4. In the dialog box, select the setting that you want to change and use the navigation pad to display additional dialog boxes.

7.18 Updating the camera

7.18.1 General

To take advantage of our latest camera firmware, it is important that you keep your camera updated. You update your camera using Flir Tools.

7.18.2 Procedure

Follow this procedure:

1. Start Flir Tools.
2. Start the camera.
3. Connect the camera to the computer using the USB cable.
4. On the *Help* menu in Flir Tools, click *Check for updates*.
5. Follow the on-screen instructions.

For technical data on this product, refer to the product catalog and/or technical data-sheets on the User Documentation CD-ROM that comes with the product.

The product catalog and the datasheets are also available at <http://support.flir.com>.

9.1 Camera housing, cables, and other items

9.1.1 Liquids

Use one of these liquids:

- Warm water
- A weak detergent solution

9.1.2 Equipment

A soft cloth

9.1.3 Procedure

Follow this procedure:

1. Soak the cloth in the liquid.
2. Twist the cloth to remove excess liquid.
3. Clean the part with the cloth.



CAUTION

Do not apply solvents or similar liquids to the camera, the cables, or other items. This can cause damage.

9.2 Infrared lens

9.2.1 Liquids

Use one of these liquids:

- A commercial lens cleaning liquid with more than 30% isopropyl alcohol.
- 96% ethyl alcohol (C_2H_5OH).
- DEE (= 'ether' = diethylether, $C_4H_{10}O$).
- 50% acetone (= dimethylketone, $(CH_3)_2CO$) + 50% ethyl alcohol (by volume). This liquid prevents drying marks on the lens.

9.2.2 Equipment

Cotton wool

9.2.3 Procedure

Follow this procedure:

1. Soak the cotton wool in the liquid.
2. Twist the cotton wool to remove excess liquid.
3. Clean the lens one time only and discard the cotton wool.



WARNING

Make sure that you read all applicable MSDS (Material Safety Data Sheets) and warning labels on containers before you use a liquid: the liquids can be dangerous.



CAUTION

- Be careful when you clean the infrared lens. The lens has a delicate anti-reflective coating.
- Do not clean the infrared lens too vigorously. This can damage the anti-reflective coating.

10.1 Moisture & water damage

10.1.1 General

It is often possible to detect moisture and water damage in a house by using an infrared camera. This is partly because the damaged area has a different heat conduction property and partly because it has a different thermal capacity to store heat than the surrounding material.

Note

Many factors can come into play as to how moisture or water damage will appear in an infrared image. For example, heating and cooling of these parts takes place at different rates depending on the material and the time of day. For this reason, it is important that other methods are used as well to check for moisture or water damage.

10.1.2 Figure

The image below shows extensive water damage on an external wall where the water has penetrated the outer facing because of an incorrectly installed window ledge.

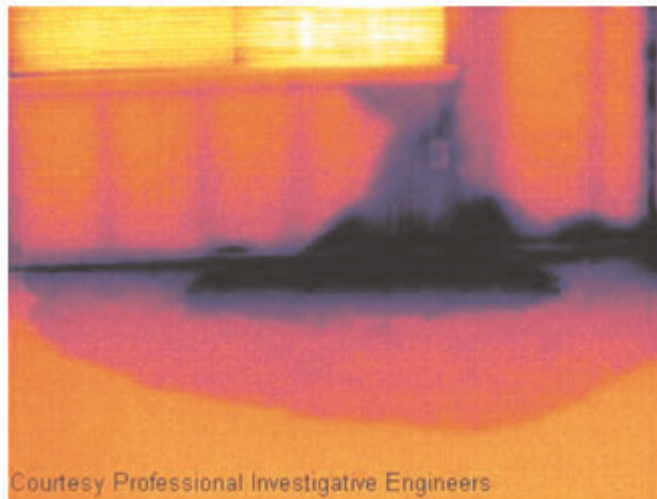

10.2 Faulty contact in socket

10.2.1 General

Depending on the type of connection a socket has, an improperly connected wire can result in local temperature increase. This temperature increase is caused by the reduced contact area between the connection point of the incoming wire and the socket, and can result in an electrical fire.

Note

A socket's construction may differ dramatically from one manufacturer to another. For this reason, different faults in a socket can lead to the same typical appearance in an infrared image. Local temperature increase can also result from improper contact between wire and socket, or from difference in load.

10.2.2 Figure

The image below shows a connection of a cable to a socket where improper contact in the connection has resulted in local temperature increase.

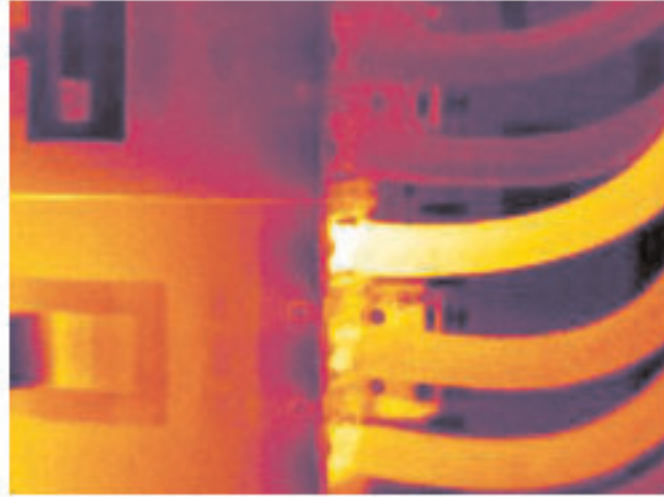

10.3 Oxidized socket

10.3.1 General

Depending on the type of socket and the environment in which the socket is installed, oxides may occur on the socket's contact surfaces. These oxides can lead to locally increased resistance when the socket is loaded, which can be seen in an infrared image as local temperature increase.

Note

A socket's construction may differ dramatically from one manufacturer to another. For this reason, different faults in a socket can lead to the same typical appearance in an infrared image.

Local temperature increase can also result from improper contact between a wire and socket, or from difference in load.

10.3.2 Figure

The image below shows a series of fuses where one fuse has a raised temperature on the contact surfaces against the fuse holder. Because of the fuse holder's blank metal, the temperature increase is not visible there, while it is visible on the fuse's ceramic material.



10.4 Insulation deficiencies

10.4.1 General

Insulation deficiencies may result from insulation losing volume over the course of time and thereby not entirely filling the cavity in a frame wall.

An infrared camera allows you to see these insulation deficiencies because they either have a different heat conduction property than sections with correctly installed insulation, and/or show the area where air is penetrating the frame of the building.

Note

When you are inspecting a building, the temperature difference between the inside and outside should be at least 10°C (18°F). Studs, water pipes, concrete columns, and similar components may resemble an insulation deficiency in an infrared image. Minor differences may also occur naturally.

10.4.2 Figure

In the image below, insulation in the roof framing is lacking. Due to the absence of insulation, air has forced its way into the roof structure, which thus takes on a different characteristic appearance in the infrared image.

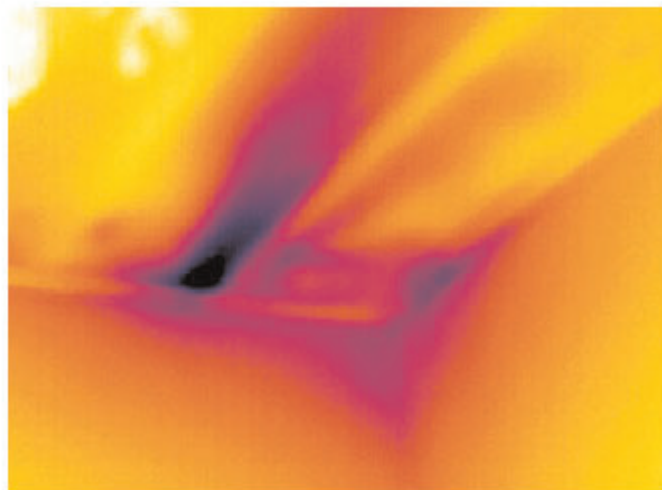

10.5 Draft

10.5.1 General

Draft can be found under baseboards, around door and window casings, and above ceiling trim. This type of draft is often possible to see with an infrared camera, as a cooler airstream cools down the surrounding surface.

Note

When you are investigating draft in a house, there should be sub-atmospheric pressure in the house. Close all doors, windows, and ventilation ducts, and allow the kitchen fan to run for a while before you take the infrared images.

An infrared image of draft often shows a typical stream pattern. You can see this stream pattern clearly in the picture below.

Also keep in mind that drafts can be concealed by heat from floor heating circuits.

10.5.2 Figure

The image below shows a ceiling hatch where faulty installation has resulted in a strong draft.

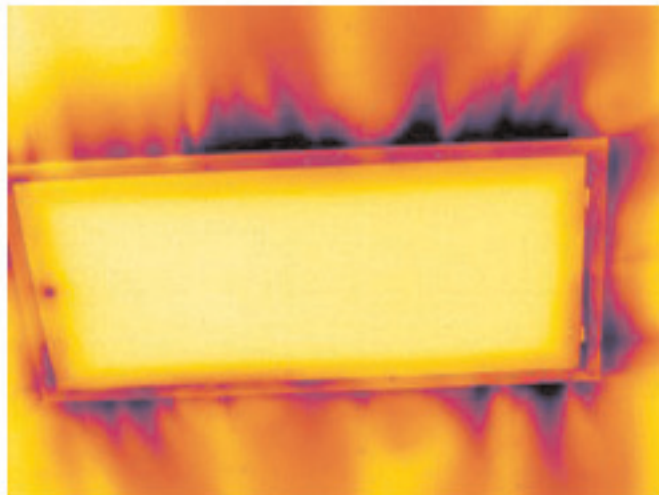

About Flir Systems

Flir Systems was established in 1978 to pioneer the development of high-performance infrared imaging systems, and is the world leader in the design, manufacture, and marketing of thermal imaging systems for a wide variety of commercial, industrial, and government applications. Today, Flir Systems embraces five major companies with outstanding achievements in infrared technology since 1958—the Swedish AGEMA Infrared Systems (formerly AGA Infrared Systems), the three United States companies Indigo Systems, FSI, and Inframetrics, and the French company Cedic. In November 2007, Extech Instruments was acquired by Flir Systems.

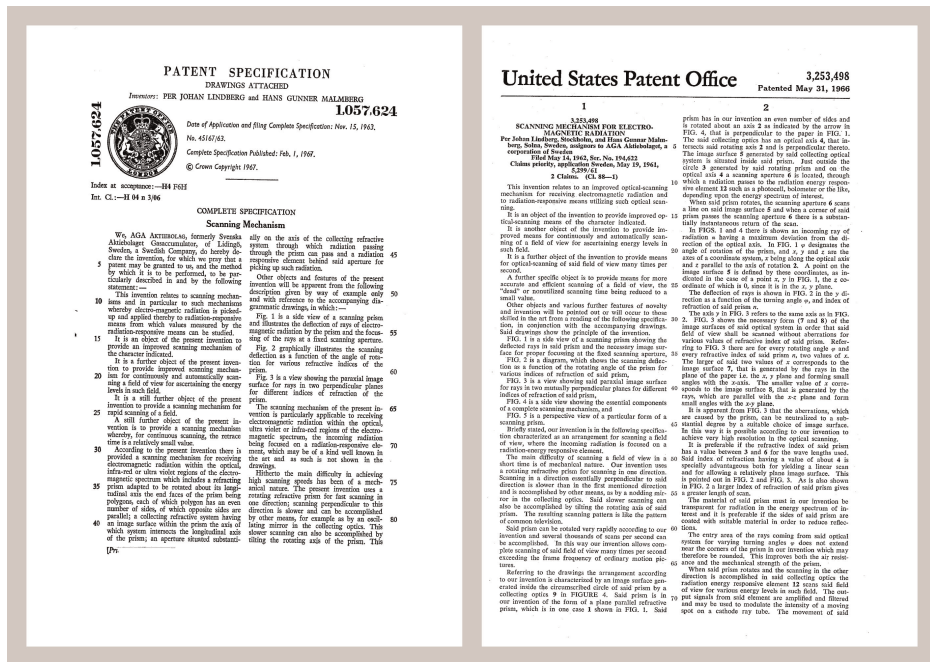

Figure 11.1 Patent documents from the early 1960s

The company has sold more than 234,000 infrared cameras worldwide for applications such as predictive maintenance, R & D, non-destructive testing, process control and automation, and machine vision, among many others.

Flir Systems has three manufacturing plants in the United States (Portland, OR, Boston, MA, Santa Barbara, CA) and one in Sweden (Stockholm). Since 2007 there is also a manufacturing plant in Tallinn, Estonia. Direct sales offices in Belgium, Brazil, China, France, Germany, Great Britain, Hong Kong, Italy, Japan, Korea, Sweden, and the USA—together with a worldwide network of agents and distributors—support our international customer base.

Flir Systems is at the forefront of innovation in the infrared camera industry. We anticipate market demand by constantly improving our existing cameras and developing new ones. The company has set milestones in product design and development such as the introduction of the first battery-operated portable camera for industrial inspections, and the first uncooled infrared camera, to mention just two innovations.



Figure 11.2 LEFT: Thermovision Model 661 from 1969. The camera weighed approximately 25 kg (55 lb.), the oscilloscope 20 kg (44 lb.), and the tripod 15 kg (33 lb.). The operator also needed a 220 VAC generator set, and a 10 L (2.6 US gallon) jar with liquid nitrogen. To the left of the oscilloscope the Polaroid attachment (6 kg/13 lb.) can be seen. RIGHT: Flir i7 from 2012. Weight: 0.34 kg (0.75 lb.), including the battery.

Flir Systems manufactures all vital mechanical and electronic components of the camera systems itself. From detector design and manufacturing, to lenses and system electronics, to final testing and calibration, all production steps are carried out and supervised by our own engineers. The in-depth expertise of these infrared specialists ensures the accuracy and reliability of all vital components that are assembled into your infrared camera.

11.1 More than just an infrared camera

At Flir Systems we recognize that our job is to go beyond just producing the best infrared camera systems. We are committed to enabling all users of our infrared camera systems to work more productively by providing them with the most powerful camera–software combination. Especially tailored software for predictive maintenance, R & D, and process monitoring is developed in-house. Most software is available in a wide variety of languages.

We support all our infrared cameras with a wide variety of accessories to adapt your equipment to the most demanding infrared applications.

11.2 Sharing our knowledge

Although our cameras are designed to be very user-friendly, there is a lot more to thermography than just knowing how to handle a camera. Therefore, Flir Systems has founded the Infrared Training Center (ITC), a separate business unit, that provides certified training courses. Attending one of the ITC courses will give you a truly hands-on learning experience.

The staff of the ITC are also there to provide you with any application support you may need in putting infrared theory into practice.

11.3 Supporting our customers

Flir Systems operates a worldwide service network to keep your camera running at all times. If you discover a problem with your camera, local service centers have all the equipment and expertise to solve it within the shortest possible time. Therefore, there is no need to send your camera to the other side of the world or to talk to someone who does not speak your language.

11.4 A few images from our facilities

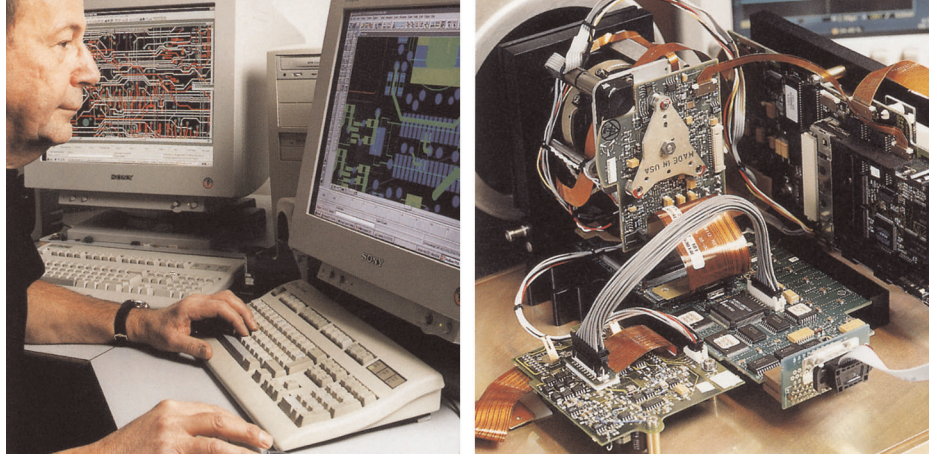

Figure 11.3 LEFT: Development of system electronics; RIGHT: Testing of an FPA detector

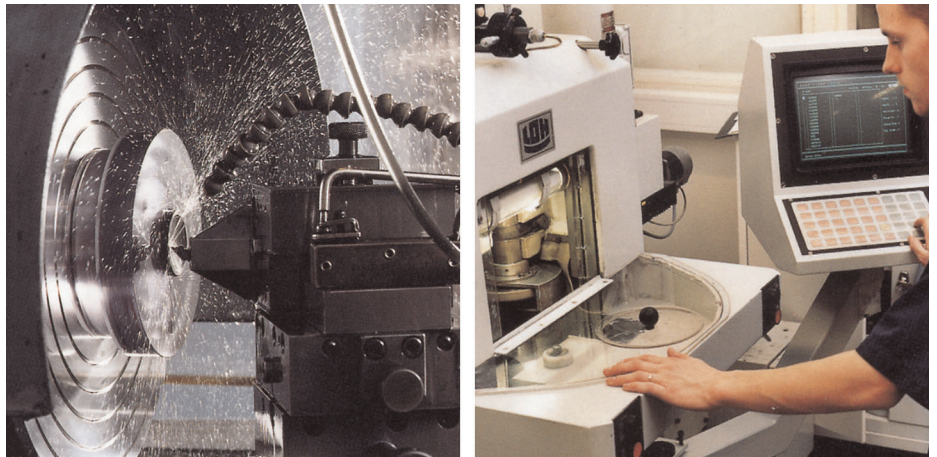

Figure 11.4 LEFT: Diamond turning machine; RIGHT: Lens polishing



Figure 11.5 LEFT: Testing of infrared cameras in the climatic chamber; RIGHT: Robot used for camera testing and calibration

absorption (absorption factor)	The amount of radiation absorbed by an object relative to the received radiation. A number between 0 and 1.
atmosphere	The gases between the object being measured and the camera, normally air.
autoadjust	A function making a camera perform an internal image correction.
autopalette	The IR image is shown with an uneven spread of colors, displaying cold objects as well as hot ones at the same time.
blackbody	Totally non-reflective object. All its radiation is due to its own temperature.
blackbody radiator	An IR radiating equipment with blackbody properties used to calibrate IR cameras.
calculated atmospheric transmission	A transmission value computed from the temperature, the relative humidity of air and the distance to the object.
cavity radiator	A bottle shaped radiator with an absorbing inside, viewed through the bottleneck.
color temperature	The temperature for which the color of a blackbody matches a specific color.
conduction	The process that makes heat diffuse into a material.
continuous adjust	A function that adjusts the image. The function works all the time, continuously adjusting brightness and contrast according to the image content.
convection	Convection is a heat transfer mode where a fluid is brought into motion, either by gravity or another force, thereby transferring heat from one place to another.
dual isotherm	An isotherm with two color bands, instead of one.
emissivity (emissivity factor)	The amount of radiation coming from an object, compared to that of a blackbody. A number between 0 and 1.
emittance	Amount of energy emitted from an object per unit of time and area (W/m^2)
environment	Objects and gases that emit radiation towards the object being measured.
estimated atmospheric transmission	A transmission value, supplied by a user, replacing a calculated one
external optics	Extra lenses, filters, heat shields etc. that can be put between the camera and the object being measured.
filter	A material transparent only to some of the infrared wavelengths.
FOV	Field of view: The horizontal angle that can be viewed through an IR lens.
FPA	Focal plane array: A type of IR detector.
graybody	An object that emits a fixed fraction of the amount of energy of a blackbody for each wavelength.
IFOV	Instantaneous field of view: A measure of the geometrical resolution of an IR camera.

image correction (internal or external)	A way of compensating for sensitivity differences in various parts of live images and also of stabilizing the camera.
infrared	Non-visible radiation, having a wavelength from about 2–13 μm .
IR	infrared
isotherm	A function highlighting those parts of an image that fall above, below or between one or more temperature intervals.
isothermal cavity	A bottle-shaped radiator with a uniform temperature viewed through the bottleneck.
Laser LocatIR	An electrically powered light source on the camera that emits laser radiation in a thin, concentrated beam to point at certain parts of the object in front of the camera.
laser pointer	An electrically powered light source on the camera that emits laser radiation in a thin, concentrated beam to point at certain parts of the object in front of the camera.
level	The center value of the temperature scale, usually expressed as a signal value.
manual adjust	A way to adjust the image by manually changing certain parameters.
NETD	Noise equivalent temperature difference. A measure of the image noise level of an IR camera.
noise	Undesired small disturbance in the infrared image
object parameters	A set of values describing the circumstances under which the measurement of an object was made, and the object itself (such as emissivity, reflected apparent temperature, distance etc.)
object signal	A non-calibrated value related to the amount of radiation received by the camera from the object.
palette	The set of colors used to display an IR image.
pixel	Stands for <i>picture element</i> . One single spot in an image.
radiance	Amount of energy emitted from an object per unit of time, area and angle ($\text{W}/\text{m}^2/\text{sr}$)
radiant power	Amount of energy emitted from an object per unit of time (W)
radiation	The process by which electromagnetic energy, is emitted by an object or a gas.
radiator	A piece of IR radiating equipment.
range	The current overall temperature measurement limitation of an IR camera. Cameras can have several ranges. Expressed as two blackbody temperatures that limit the current calibration.
reference temperature	A temperature which the ordinary measured values can be compared with.
reflection	The amount of radiation reflected by an object relative to the received radiation. A number between 0 and 1.
relative humidity	Relative humidity represents the ratio between the current water vapour mass in the air and the maximum it may contain in saturation conditions.
saturation color	The areas that contain temperatures outside the present level/span settings are colored with the saturation colors. The saturation colors contain an 'overflow' color and an 'underflow' color. There is also a third red saturation color that marks everything saturated by the detector indicating that the range should probably be changed.

span	The interval of the temperature scale, usually expressed as a signal value.
spectral (radiant) emittance	Amount of energy emitted from an object per unit of time, area and wavelength ($W/m^2/\mu m$)
temperature difference, or difference of temperature.	A value which is the result of a subtraction between two temperature values.
temperature range	The current overall temperature measurement limitation of an IR camera. Cameras can have several ranges. Expressed as two blackbody temperatures that limit the current calibration.
temperature scale	The way in which an IR image currently is displayed. Expressed as two temperature values limiting the colors.
thermogram	infrared image
transmission (or transmittance) factor	Gases and materials can be more or less transparent. Transmission is the amount of IR radiation passing through them. A number between 0 and 1.
transparent isotherm	An isotherm showing a linear spread of colors, instead of covering the highlighted parts of the image.
visual	Refers to the video mode of a IR camera, as opposed to the normal, thermographic mode. When a camera is in video mode it captures ordinary video images, while thermographic images are captured when the camera is in IR mode.

13.1 Introduction

An infrared camera measures and images the emitted infrared radiation from an object. The fact that radiation is a function of object surface temperature makes it possible for the camera to calculate and display this temperature.

However, the radiation measured by the camera does not only depend on the temperature of the object but is also a function of the emissivity. Radiation also originates from the surroundings and is reflected in the object. The radiation from the object and the reflected radiation will also be influenced by the absorption of the atmosphere.

To measure temperature accurately, it is therefore necessary to compensate for the effects of a number of different radiation sources. This is done on-line automatically by the camera. The following object parameters must, however, be supplied for the camera:

- The emissivity of the object
- The reflected apparent temperature
- The distance between the object and the camera
- The relative humidity
- Temperature of the atmosphere

13.2 Emissivity

The most important object parameter to set correctly is the emissivity which, in short, is a measure of how much radiation is emitted from the object, compared to that from a perfect blackbody of the same temperature.

Normally, object materials and surface treatments exhibit emissivity ranging from approximately 0.1 to 0.95. A highly polished (mirror) surface falls below 0.1, while an oxidized or painted surface has a higher emissivity. Oil-based paint, regardless of color in the visible spectrum, has an emissivity over 0.9 in the infrared. Human skin exhibits an emissivity 0.97 to 0.98.

Non-oxidized metals represent an extreme case of perfect opacity and high reflexivity, which does not vary greatly with wavelength. Consequently, the emissivity of metals is low – only increasing with temperature. For non-metals, emissivity tends to be high, and decreases with temperature.

13.2.1 Finding the emissivity of a sample

13.2.1.1 Step 1: Determining reflected apparent temperature

Use one of the following two methods to determine reflected apparent temperature:

13.2.1.1.1 Method 1: Direct method

Follow this procedure:

1. Look for possible reflection sources, considering that the incident angle = reflection angle ($a = b$).

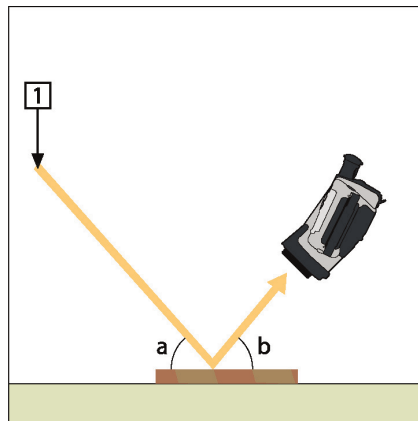

Figure 13.1 1 = Reflection source

2. If the reflection source is a spot source, modify the source by obstructing it using a piece of cardboard.

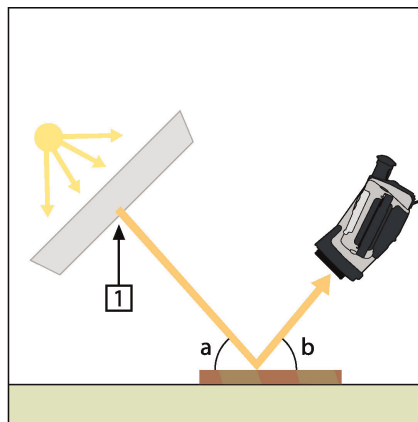

Figure 13.2 1 = Reflection source

3. Measure the radiation intensity (= apparent temperature) from the reflecting source using the following settings:

- Emissivity: 1.0
- D_{obj} : 0

You can measure the radiation intensity using one of the following two methods:

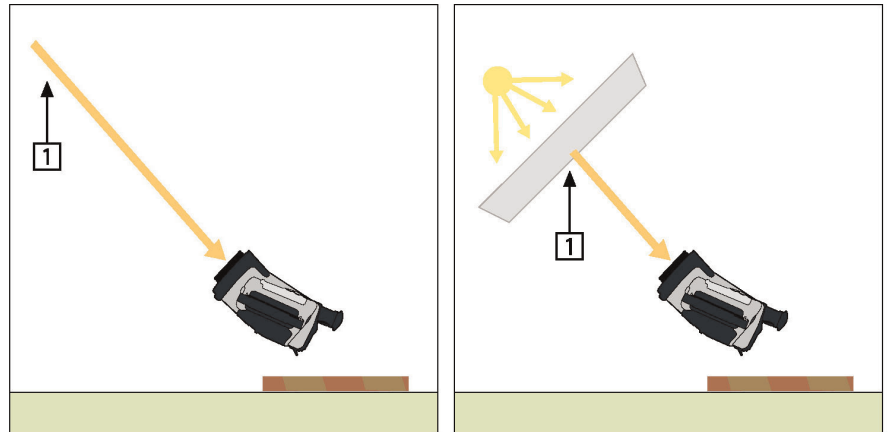

Figure 13.3 1 = Reflection source

Note

Using a thermocouple to measure reflected apparent temperature is not recommended for two important reasons:

- A thermocouple does not measure radiation intensity
- A thermocouple requires a very good thermal contact to the surface, usually by gluing and covering the sensor by a thermal isolator.

13.2.1.1.2 Method 2: Reflector method

Follow this procedure:

1. Crumble up a large piece of aluminum foil.
2. Uncrumble the aluminum foil and attach it to a piece of cardboard of the same size.
3. Put the piece of cardboard in front of the object you want to measure. Make sure that the side with aluminum foil points to the camera.
4. Set the emissivity to 1.0.
5. Measure the apparent temperature of the aluminum foil and write it down.

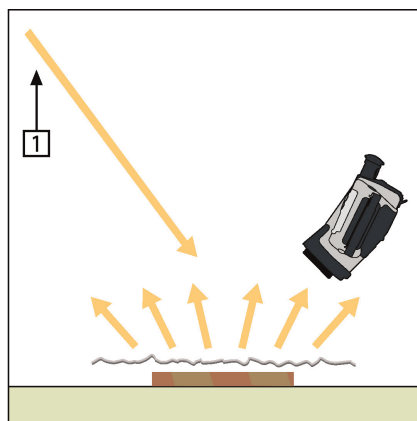

Figure 13.4 Measuring the apparent temperature of the aluminum foil.

13.2.1.2 Step 2: Determining the emissivity

Follow this procedure:

1. Select a place to put the sample.
2. Determine and set reflected apparent temperature according to the previous procedure.
3. Put a piece of electrical tape with known high emissivity on the sample.
4. Heat the sample at least 20 K above room temperature. Heating must be reasonably even.
5. Focus and auto-adjust the camera, and freeze the image.
6. Adjust *Level* and *Span* for best image brightness and contrast.
7. Set emissivity to that of the tape (usually 0.97).
8. Measure the temperature of the tape using one of the following measurement functions:
 - *Isotherm* (helps you to determine both the temperature and how evenly you have heated the sample)
 - *Spot* (simpler)
 - *Box Avg* (good for surfaces with varying emissivity).
9. Write down the temperature.
10. Move your measurement function to the sample surface.
11. Change the emissivity setting until you read the same temperature as your previous measurement.
12. Write down the emissivity.

Note

- Avoid forced convection
- Look for a thermally stable surrounding that will not generate spot reflections
- Use high quality tape that you know is not transparent, and has a high emissivity you are certain of
- This method assumes that the temperature of your tape and the sample surface are the same. If they are not, your emissivity measurement will be wrong.

13.3 Reflected apparent temperature

This parameter is used to compensate for the radiation reflected in the object. If the emissivity is low and the object temperature relatively far from that of the reflected it will be important to set and compensate for the reflected apparent temperature correctly.

13.4 Distance

The distance is the distance between the object and the front lens of the camera. This parameter is used to compensate for the following two facts:

- That radiation from the target is absorbed by the atmosphere between the object and the camera.
- That radiation from the atmosphere itself is detected by the camera.

13.5 Relative humidity

The camera can also compensate for the fact that the transmittance is also dependent on the relative humidity of the atmosphere. To do this set the relative humidity to the correct value. For short distances and normal humidity the relative humidity can normally be left at a default value of 50%.

13.6 Other parameters

In addition, some cameras and analysis programs from Flir Systems allow you to compensate for the following parameters:

- Atmospheric temperature – *i.e.* the temperature of the atmosphere between the camera and the target
- External optics temperature – *i.e.* the temperature of any external lenses or windows used in front of the camera

- External optics transmittance – *i.e.* the transmission of any external lenses or windows used in front of the camera

Before the year 1800, the existence of the infrared portion of the electromagnetic spectrum wasn't even suspected. The original significance of the infrared spectrum, or simply 'the infrared' as it is often called, as a form of heat radiation is perhaps less obvious today than it was at the time of its discovery by Herschel in 1800.

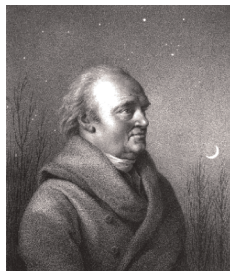

Figure 14.1 Sir William Herschel (1738–1822)

The discovery was made accidentally during the search for a new optical material. Sir William Herschel – Royal Astronomer to King George III of England, and already famous for his discovery of the planet Uranus – was searching for an optical filter material to reduce the brightness of the sun's image in telescopes during solar observations. While testing different samples of colored glass which gave similar reductions in brightness he was intrigued to find that some of the samples passed very little of the sun's heat, while others passed so much heat that he risked eye damage after only a few seconds' observation.

Herschel was soon convinced of the necessity of setting up a systematic experiment, with the objective of finding a single material that would give the desired reduction in brightness as well as the maximum reduction in heat. He began the experiment by actually repeating Newton's prism experiment, but looking for the heating effect rather than the visual distribution of intensity in the spectrum. He first blackened the bulb of a sensitive mercury-in-glass thermometer with ink, and with this as his radiation detector he proceeded to test the heating effect of the various colors of the spectrum formed on the top of a table by passing sunlight through a glass prism. Other thermometers, placed outside the sun's rays, served as controls.

As the blackened thermometer was moved slowly along the colors of the spectrum, the temperature readings showed a steady increase from the violet end to the red end. This was not entirely unexpected, since the Italian researcher, Landriani, in a similar experiment in 1777 had observed much the same effect. It was Herschel, however, who was the first to recognize that there must be a point where the heating effect reaches a maximum, and that measurements confined to the visible portion of the spectrum failed to locate this point.



Figure 14.2 Marsilio Landriani (1746–1815)

Moving the thermometer into the dark region beyond the red end of the spectrum, Herschel confirmed that the heating continued to increase. The maximum point, when he found it, lay well beyond the red end – in what is known today as the 'infrared wavelengths'.

When Herschel revealed his discovery, he referred to this new portion of the electromagnetic spectrum as the 'thermometrical spectrum'. The radiation itself he sometimes referred to as 'dark heat', or simply 'the invisible rays'. Ironically, and contrary to popular opinion, it wasn't Herschel who originated the term 'infrared'. The word only began to appear in print around 75 years later, and it is still unclear who should receive credit as the originator.

Herschel's use of glass in the prism of his original experiment led to some early controversies with his contemporaries about the actual existence of the infrared wavelengths. Different investigators, in attempting to confirm his work, used various types of glass indiscriminately, having different transparencies in the infrared. Through his later experiments, Herschel was aware of the limited transparency of glass to the newly-discovered thermal radiation, and he was forced to conclude that optics for the infrared would probably be doomed to the use of reflective elements exclusively (i.e. plane and curved mirrors). Fortunately, this proved to be true only until 1830, when the Italian investigator, Melloni, made his great discovery that naturally occurring rock salt (NaCl) – which was available in large enough natural crystals to be made into lenses and prisms – is remarkably transparent to the infrared. The result was that rock salt became the principal infrared optical material, and remained so for the next hundred years, until the art of synthetic crystal growing was mastered in the 1930's.



Figure 14.3 Macedonio Melloni (1798–1854)

Thermometers, as radiation detectors, remained unchallenged until 1829, the year Nobili invented the thermocouple. (Herschel's own thermometer could be read to 0.2 °C (0.036 °F), and later models were able to be read to 0.05 °C (0.09 °F)). Then a breakthrough occurred; Melloni connected a number of thermocouples in series to form the first thermopile. The new device was at least 40 times as sensitive as the best thermometer of the day for detecting heat radiation – capable of detecting the heat from a person standing three meters away.

The first so-called 'heat-picture' became possible in 1840, the result of work by Sir John Herschel, son of the discoverer of the infrared and a famous astronomer in his own right. Based upon the differential evaporation of a thin film of oil when exposed to a heat pattern focused upon it, the thermal image could be seen by reflected light where the interference effects of the oil film made the image visible to the eye. Sir John also managed to obtain a primitive record of the thermal image on paper, which he called a 'thermograph'.



Figure 14.4 Samuel P. Langley (1834–1906)

The improvement of infrared-detector sensitivity progressed slowly. Another major breakthrough, made by Langley in 1880, was the invention of the bolometer. This consisted of a thin blackened strip of platinum connected in one arm of a Wheatstone bridge circuit upon which the infrared radiation was focused and to which a sensitive galvanometer responded. This instrument is said to have been able to detect the heat from a cow at a distance of 400 meters.

An English scientist, Sir James Dewar, first introduced the use of liquefied gases as cooling agents (such as liquid nitrogen with a temperature of $-196\text{ }^{\circ}\text{C}$ ($-320.8\text{ }^{\circ}\text{F}$)) in low temperature research. In 1892 he invented a unique vacuum insulating container in which it is possible to store liquefied gases for entire days. The common 'thermos bottle', used for storing hot and cold drinks, is based upon his invention.

Between the years 1900 and 1920, the inventors of the world 'discovered' the infrared. Many patents were issued for devices to detect personnel, artillery, aircraft, ships – and even icebergs. The first operating systems, in the modern sense, began to be developed during the 1914–18 war, when both sides had research programs devoted to the military exploitation of the infrared. These programs included experimental systems for enemy intrusion/detection, remote temperature sensing, secure communications, and 'flying torpedo' guidance. An infrared search system tested during this period was able to detect an approaching airplane at a distance of 1.5 km (0.94 miles), or a person more than 300 meters (984 ft.) away.

The most sensitive systems up to this time were all based upon variations of the bolometer idea, but the period between the two wars saw the development of two revolutionary new infrared detectors: the image converter and the photon detector. At first, the image converter received the greatest attention by the military, because it enabled an observer for the first time in history to literally 'see in the dark'. However, the sensitivity of the image converter was limited to the near infrared wavelengths, and the most interesting military targets (i.e. enemy soldiers) had to be illuminated by infrared search beams. Since this involved the risk of giving away the observer's position to a similarly-equipped enemy observer, it is understandable that military interest in the image converter eventually faded.

The tactical military disadvantages of so-called 'active' (i.e. search beam-equipped) thermal imaging systems provided impetus following the 1939–45 war for extensive secret military infrared-research programs into the possibilities of developing 'passive' (no search beam) systems around the extremely sensitive photon detector. During this period, military secrecy regulations completely prevented disclosure of the status of infrared-imaging technology. This secrecy only began to be lifted in the middle of the 1950's, and from that time adequate thermal-imaging devices finally began to be available to civilian science and industry.

15.1 Introduction

The subjects of infrared radiation and the related technique of thermography are still new to many who will use an infrared camera. In this section the theory behind thermography will be given.

15.2 The electromagnetic spectrum

The electromagnetic spectrum is divided arbitrarily into a number of wavelength regions, called *bands*, distinguished by the methods used to produce and detect the radiation. There is no fundamental difference between radiation in the different bands of the electromagnetic spectrum. They are all governed by the same laws and the only differences are those due to differences in wavelength.

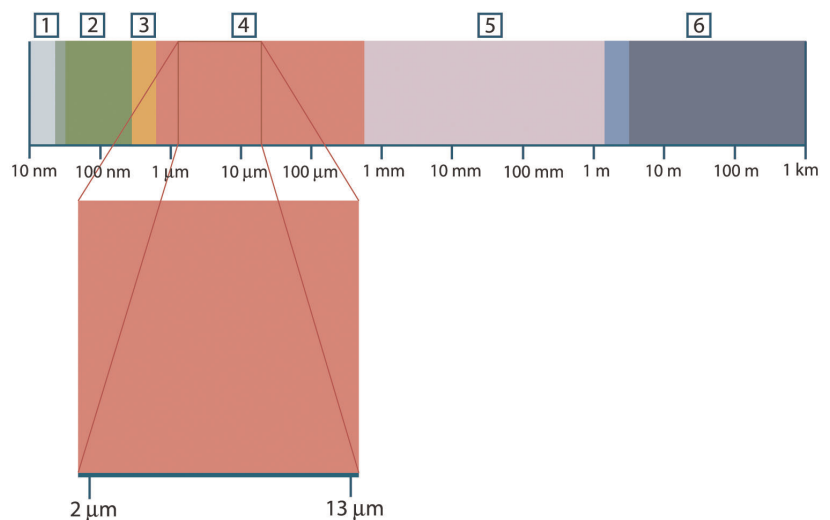

Figure 15.1 The electromagnetic spectrum. 1: X-ray; 2: UV; 3: Visible; 4: IR; 5: Microwaves; 6: Radiowaves.

Thermography makes use of the infrared spectral band. At the short-wavelength end the boundary lies at the limit of visual perception, in the deep red. At the long-wavelength end it merges with the microwave radio wavelengths, in the millimeter range.

The infrared band is often further subdivided into four smaller bands, the boundaries of which are also arbitrarily chosen. They include: the *near infrared* (0.75–3 μm), the *middle infrared* (3–6 μm), the *far infrared* (6–15 μm) and the *extreme infrared* (15–100 μm). Although the wavelengths are given in μm (micrometers), other units are often still used to measure wavelength in this spectral region, e.g. nanometer (nm) and Ångström (Å).

The relationships between the different wavelength measurements is:

$$10\,000\ \text{Å} = 1\,000\ \text{nm} = 1\ \mu = 1\ \mu\text{m}$$

15.3 Blackbody radiation

A blackbody is defined as an object which absorbs all radiation that impinges on it at any wavelength. The apparent misnomer *black* relating to an object emitting radiation is explained by Kirchhoff's Law (after *Gustav Robert Kirchhoff*, 1824–1887), which states that a body capable of absorbing all radiation at any wavelength is equally capable in the emission of radiation.

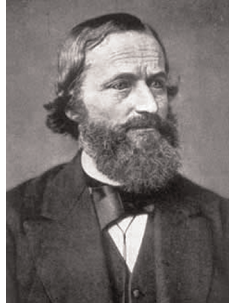

Figure 15.2 Gustav Robert Kirchhoff (1824–1887)

The construction of a blackbody source is, in principle, very simple. The radiation characteristics of an aperture in an isotherm cavity made of an opaque absorbing material represents almost exactly the properties of a blackbody. A practical application of the principle to the construction of a perfect absorber of radiation consists of a box that is light tight except for an aperture in one of the sides. Any radiation which then enters the hole is scattered and absorbed by repeated reflections so only an infinitesimal fraction can possibly escape. The blackness which is obtained at the aperture is nearly equal to a blackbody and almost perfect for all wavelengths.

By providing such an isothermal cavity with a suitable heater it becomes what is termed a *cavity radiator*. An isothermal cavity heated to a uniform temperature generates blackbody radiation, the characteristics of which are determined solely by the temperature of the cavity. Such cavity radiators are commonly used as sources of radiation in temperature reference standards in the laboratory for calibrating thermographic instruments, such as a Flir Systems camera for example.

If the temperature of blackbody radiation increases to more than 525°C (977°F), the source begins to be visible so that it appears to the eye no longer black. This is the incipient red heat temperature of the radiator, which then becomes orange or yellow as the temperature increases further. In fact, the definition of the so-called *color temperature* of an object is the temperature to which a blackbody would have to be heated to have the same appearance.

Now consider three expressions that describe the radiation emitted from a blackbody.

15.3.1 Planck's law



Figure 15.3 Max Planck (1858–1947)

Max Planck (1858–1947) was able to describe the spectral distribution of the radiation from a blackbody by means of the following formula:

$$W_{\lambda b} = \frac{2\pi hc^2}{\lambda^5 \left(e^{\frac{hc}{\lambda kT}} - 1 \right)} \times 10^{-6} [\text{Watt} / \text{m}^2, \mu\text{m}]$$

where:

$W_{\lambda b}$	Blackbody spectral radiant emittance at wavelength λ .
c	Velocity of light = 3×10^8 m/s
h	Planck's constant = 6.6×10^{-34} Joule sec.
k	Boltzmann's constant = 1.4×10^{-23} Joule/K.
T	Absolute temperature (K) of a blackbody.
λ	Wavelength (μm).

Note

The factor 10^{-6} is used since spectral emittance in the curves is expressed in Watt/m², μm .

Planck's formula, when plotted graphically for various temperatures, produces a family of curves. Following any particular Planck curve, the spectral emittance is zero at $\lambda = 0$, then increases rapidly to a maximum at a wavelength λ_{max} and after passing it approaches zero again at very long wavelengths. The higher the temperature, the shorter the wavelength at which maximum occurs.

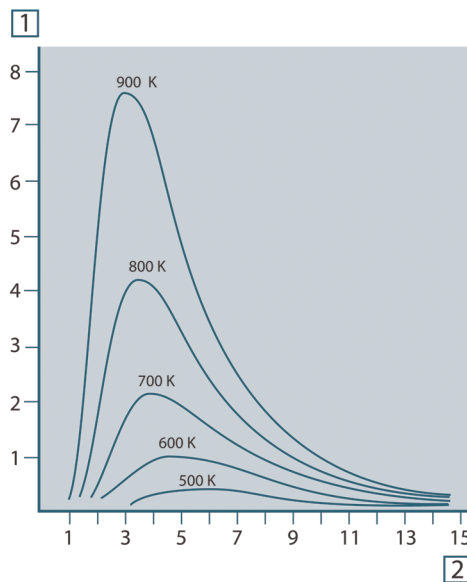

Figure 15.4 Blackbody spectral radiant emittance according to Planck's law, plotted for various absolute temperatures. 1: Spectral radiant emittance ($\text{W}/\text{cm}^2 \times 10^3(\mu\text{m})$); 2: Wavelength (μm)

15.3.2 Wien's displacement law

By differentiating Planck's formula with respect to λ , and finding the maximum, we have:

$$\lambda_{\text{max}} = \frac{2898}{T} [\mu\text{m}]$$

This is Wien's formula (after *Wilhelm Wien*, 1864–1928), which expresses mathematically the common observation that colors vary from red to orange or yellow as the temperature of a thermal radiator increases. The wavelength of the color is the same as the wavelength calculated for λ_{max} . A good approximation of the value of λ_{max} for a given blackbody temperature is obtained by applying the rule-of-thumb $3\,000/T \mu\text{m}$. Thus, a very hot star such as Sirius (11 000 K), emitting bluish-white light, radiates with the peak of spectral radiant emittance occurring within the invisible ultraviolet spectrum, at wavelength $0.27 \mu\text{m}$.

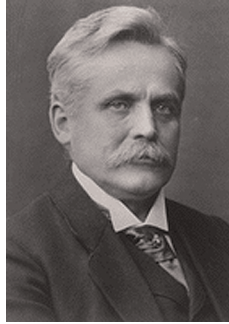

Figure 15.5 Wilhelm Wien (1864–1928)

The sun (approx. 6 000 K) emits yellow light, peaking at about 0.5 μm in the middle of the visible light spectrum.

At room temperature (300 K) the peak of radiant emittance lies at 9.7 μm , in the far infrared, while at the temperature of liquid nitrogen (77 K) the maximum of the almost insignificant amount of radiant emittance occurs at 38 μm , in the extreme infrared wavelengths.

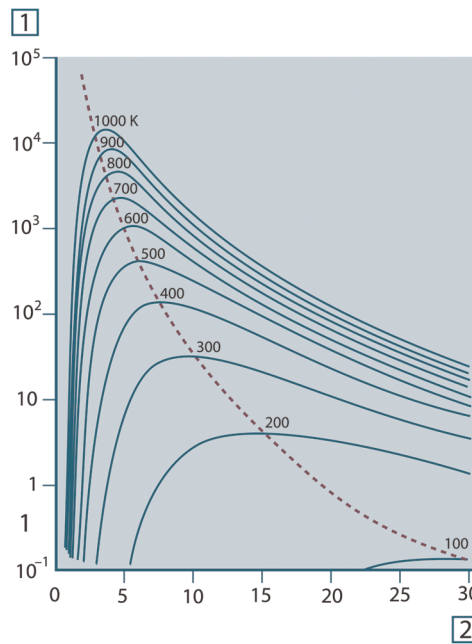

Figure 15.6 Planckian curves plotted on semi-log scales from 100 K to 1000 K. The dotted line represents the locus of maximum radiant emittance at each temperature as described by Wien's displacement law. 1: Spectral radiant emittance (W/cm^2 (μm)); 2: Wavelength (μm).

15.3.3 Stefan-Boltzmann's law

By integrating Planck's formula from $\lambda = 0$ to $\lambda = \infty$, we obtain the total radiant emittance (W_b) of a blackbody:

$$W_b = \sigma T^4 \quad [\text{Watt}/\text{m}^2]$$

This is the Stefan-Boltzmann formula (after *Josef Stefan*, 1835–1893, and *Ludwig Boltzmann*, 1844–1906), which states that the total emissive power of a blackbody is proportional to the fourth power of its absolute temperature. Graphically, W_b represents the area below the Planck curve for a particular temperature. It can be shown that the radiant emittance in the interval $\lambda = 0$ to λ_{max} is only 25% of the total, which represents about the amount of the sun's radiation which lies inside the visible light spectrum.



Figure 15.7 Josef Stefan (1835–1893), and Ludwig Boltzmann (1844–1906)

Using the Stefan-Boltzmann formula to calculate the power radiated by the human body, at a temperature of 300 K and an external surface area of approx. 2 m², we obtain 1 kW. This power loss could not be sustained if it were not for the compensating absorption of radiation from surrounding surfaces, at room temperatures which do not vary too drastically from the temperature of the body – or, of course, the addition of clothing.

15.3.4 Non-blackbody emitters

So far, only blackbody radiators and blackbody radiation have been discussed. However, real objects almost never comply with these laws over an extended wavelength region – although they may approach the blackbody behavior in certain spectral intervals. For example, a certain type of white paint may appear perfectly *white* in the visible light spectrum, but becomes distinctly *gray* at about 2 μm, and beyond 3 μm it is almost *black*.

There are three processes which can occur that prevent a real object from acting like a blackbody: a fraction of the incident radiation α may be absorbed, a fraction ρ may be reflected, and a fraction τ may be transmitted. Since all of these factors are more or less wavelength dependent, the subscript λ is used to imply the spectral dependence of their definitions. Thus:

- The spectral absorptance α_λ = the ratio of the spectral radiant power absorbed by an object to that incident upon it.
- The spectral reflectance ρ_λ = the ratio of the spectral radiant power reflected by an object to that incident upon it.
- The spectral transmittance τ_λ = the ratio of the spectral radiant power transmitted through an object to that incident upon it.

The sum of these three factors must always add up to the whole at any wavelength, so we have the relation:

$$\alpha_\lambda + \rho_\lambda + \tau_\lambda = 1$$

For opaque materials $\tau_\lambda = 0$ and the relation simplifies to:

$$\epsilon_\lambda + \rho_\lambda = 1$$

Another factor, called the emissivity, is required to describe the fraction ϵ of the radiant emittance of a blackbody produced by an object at a specific temperature. Thus, we have the definition:

The spectral emissivity ϵ_λ = the ratio of the spectral radiant power from an object to that from a blackbody at the same temperature and wavelength.

Expressed mathematically, this can be written as the ratio of the spectral emittance of the object to that of a blackbody as follows:

$$\epsilon_\lambda = \frac{W_{\lambda o}}{W_{\lambda b}}$$

Generally speaking, there are three types of radiation source, distinguished by the ways in which the spectral emittance of each varies with wavelength.

- A blackbody, for which $\epsilon_\lambda = \epsilon = 1$
- A graybody, for which $\epsilon_\lambda = \epsilon = \text{constant less than 1}$

- A selective radiator, for which ε varies with wavelength

According to Kirchhoff's law, for any material the spectral emissivity and spectral absorptance of a body are equal at any specified temperature and wavelength. That is:

$$\varepsilon_\lambda = \alpha_\lambda$$

From this we obtain, for an opaque material (since $\alpha_\lambda + \rho_\lambda = 1$):

$$\varepsilon_\lambda + \rho_\lambda = 1$$

For highly polished materials ε_λ approaches zero, so that for a perfectly reflecting material (*i.e.* a perfect mirror) we have:

$$\rho_\lambda = 1$$

For a graybody radiator, the Stefan-Boltzmann formula becomes:

$$W = \varepsilon\sigma T^4 \text{ [Watt/m}^2\text{]}$$

This states that the total emissive power of a graybody is the same as a blackbody at the same temperature reduced in proportion to the value of ε from the graybody.

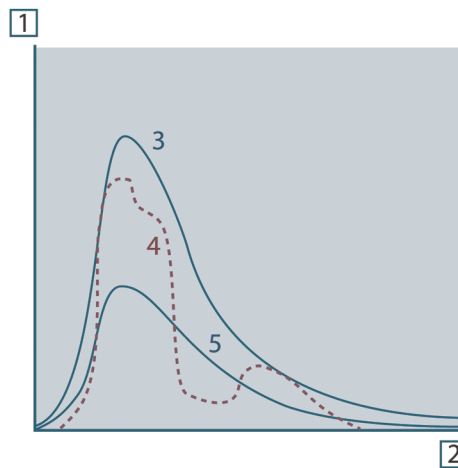

Figure 15.8 Spectral radiant emittance of three types of radiators. 1: Spectral radiant emittance; 2: Wavelength; 3: Blackbody; 4: Selective radiator; 5: Graybody.

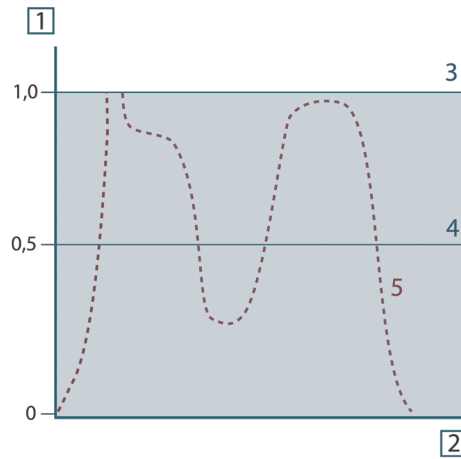

Figure 15.9 Spectral emissivity of three types of radiators. 1: Spectral emissivity; 2: Wavelength; 3: Black-body; 4: Graybody; 5: Selective radiator.

15.4 Infrared semi-transparent materials

Consider now a non-metallic, semi-transparent body – let us say, in the form of a thick flat plate of plastic material. When the plate is heated, radiation generated within its volume must work its way toward the surfaces through the material in which it is partially absorbed. Moreover, when it arrives at the surface, some of it is reflected back into the interior. The back-reflected radiation is again partially absorbed, but some of it arrives at the other surface, through which most of it escapes; part of it is reflected back again. Although the progressive reflections become weaker and weaker they must all be added up when the total emittance of the plate is sought. When the resulting geometrical series is summed, the effective emissivity of a semi-transparent plate is obtained as:

$$\varepsilon_{\lambda} = \frac{(1 - \rho_{\lambda})(1 - \tau_{\lambda})}{1 - \rho_{\lambda}\tau_{\lambda}}$$

When the plate becomes opaque this formula is reduced to the single formula:

$$\varepsilon_{\lambda} = 1 - \rho_{\lambda}$$

This last relation is a particularly convenient one, because it is often easier to measure reflectance than to measure emissivity directly.

As already mentioned, when viewing an object, the camera receives radiation not only from the object itself. It also collects radiation from the surroundings reflected via the object surface. Both these radiation contributions become attenuated to some extent by the atmosphere in the measurement path. To this comes a third radiation contribution from the atmosphere itself.

This description of the measurement situation, as illustrated in the figure below, is so far a fairly true description of the real conditions. What has been neglected could for instance be sun light scattering in the atmosphere or stray radiation from intense radiation sources outside the field of view. Such disturbances are difficult to quantify, however, in most cases they are fortunately small enough to be neglected. In case they are not negligible, the measurement configuration is likely to be such that the risk for disturbance is obvious, at least to a trained operator. It is then his responsibility to modify the measurement situation to avoid the disturbance e.g. by changing the viewing direction, shielding off intense radiation sources etc.

Accepting the description above, we can use the figure below to derive a formula for the calculation of the object temperature from the calibrated camera output.

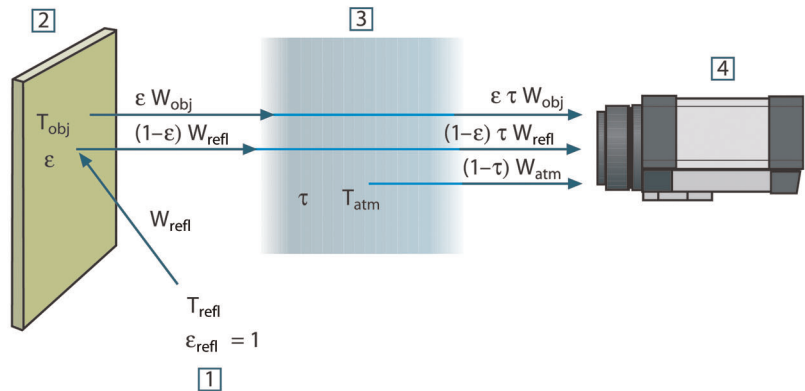

Figure 16.1 A schematic representation of the general thermographic measurement situation. 1: Surroundings; 2: Object; 3: Atmosphere; 4: Camera

Assume that the received radiation power W from a blackbody source of temperature T_{source} on short distance generates a camera output signal U_{source} that is proportional to the power input (power linear camera). We can then write (Equation 1):

$$U_{\text{source}} = CW(T_{\text{source}})$$

or, with simplified notation:

$$U_{\text{source}} = CW_{\text{source}}$$

where C is a constant.

Should the source be a graybody with emittance ϵ , the received radiation would consequently be $\epsilon W_{\text{source}}$.

We are now ready to write the three collected radiation power terms:

1. *Emission from the object* = $\epsilon\tau W_{\text{obj}}$, where ϵ is the emittance of the object and τ is the transmittance of the atmosphere. The object temperature is T_{obj} .

2. *Reflected emission from ambient sources* = $(1 - \varepsilon)\tau W_{\text{refl}}$, where $(1 - \varepsilon)$ is the reflectance of the object. The ambient sources have the temperature T_{refl} .

It has here been assumed that the temperature T_{refl} is the same for all emitting surfaces within the halfsphere seen from a point on the object surface. This is of course sometimes a simplification of the true situation. It is, however, a necessary simplification in order to derive a workable formula, and T_{refl} can – at least theoretically – be given a value that represents an efficient temperature of a complex surrounding.

Note also that we have assumed that the emittance for the surroundings = 1. This is correct in accordance with Kirchhoff's law: All radiation impinging on the surrounding surfaces will eventually be absorbed by the same surfaces. Thus the emittance = 1. (Note though that the latest discussion requires the complete sphere around the object to be considered.)

3. *Emission from the atmosphere* = $(1 - \tau)\tau W_{\text{atm}}$, where $(1 - \tau)$ is the emittance of the atmosphere. The temperature of the atmosphere is T_{atm} .

The total received radiation power can now be written (Equation 2):

$$W_{\text{tot}} = \varepsilon\tau W_{\text{obj}} + (1 - \varepsilon)\tau W_{\text{refl}} + (1 - \tau)W_{\text{atm}}$$

We multiply each term by the constant C of Equation 1 and replace the CW products by the corresponding U according to the same equation, and get (Equation 3):

$$U_{\text{tot}} = \varepsilon\tau U_{\text{obj}} + (1 - \varepsilon)\tau U_{\text{refl}} + (1 - \tau)U_{\text{atm}}$$

Solve Equation 3 for U_{obj} (Equation 4):

$$U_{\text{obj}} = \frac{1}{\varepsilon\tau}U_{\text{tot}} - \frac{1 - \varepsilon}{\varepsilon}U_{\text{refl}} - \frac{1 - \tau}{\varepsilon\tau}U_{\text{atm}}$$

This is the general measurement formula used in all the Flir Systems thermographic equipment. The voltagages of the formula are:

Table 16.1 Voltages

U_{obj}	Calculated camera output voltage for a blackbody of temperature T_{obj} i.e. a voltage that can be directly converted into true requested object temperature.
U_{tot}	Measured camera output voltage for the actual case.
U_{refl}	Theoretical camera output voltage for a blackbody of temperature T_{refl} according to the calibration.
U_{atm}	Theoretical camera output voltage for a blackbody of temperature T_{atm} according to the calibration.

The operator has to supply a number of parameter values for the calculation:

- the object emittance ε ,
- the relative humidity,
- T_{atm}
- object distance (D_{obj})
- the (effective) temperature of the object surroundings, or the reflected ambient temperature T_{refl} , and
- the temperature of the atmosphere T_{atm}

This task could sometimes be a heavy burden for the operator since there are normally no easy ways to find accurate values of emittance and atmospheric transmittance for the actual case. The two temperatures are normally less of a problem provided the surroundings do not contain large and intense radiation sources.

A natural question in this connection is: How important is it to know the right values of these parameters? It could though be of interest to get a feeling for this problem already here by looking into some different measurement cases and compare the relative

magnitudes of the three radiation terms. This will give indications about when it is important to use correct values of which parameters.

The figures below illustrates the relative magnitudes of the three radiation contributions for three different object temperatures, two emittances, and two spectral ranges: SW and LW. Remaining parameters have the following fixed values:

- $\tau = 0.88$
- $T_{\text{refl}} = +20^{\circ}\text{C}$ ($+68^{\circ}\text{F}$)
- $T_{\text{atm}} = +20^{\circ}\text{C}$ ($+68^{\circ}\text{F}$)

It is obvious that measurement of low object temperatures are more critical than measuring high temperatures since the 'disturbing' radiation sources are relatively much stronger in the first case. Should also the object emittance be low, the situation would be still more difficult.

We have finally to answer a question about the importance of being allowed to use the calibration curve above the highest calibration point, what we call extrapolation. Imagine that we in a certain case measure $U_{\text{tot}} = 4.5$ volts. The highest calibration point for the camera was in the order of 4.1 volts, a value unknown to the operator. Thus, even if the object happened to be a blackbody, i.e. $U_{\text{obj}} = U_{\text{tot}}$, we are actually performing extrapolation of the calibration curve when converting 4.5 volts into temperature.

Let us now assume that the object is not black, it has an emittance of 0.75, and the transmittance is 0.92. We also assume that the two second terms of Equation 4 amount to 0.5 volts together. Computation of U_{obj} by means of Equation 4 then results in $U_{\text{obj}} = 4.5 / 0.75 / 0.92 - 0.5 = 6.0$. This is a rather extreme extrapolation, particularly when considering that the video amplifier might limit the output to 5 volts! Note, though, that the application of the calibration curve is a theoretical procedure where no electronic or other limitations exist. We trust that if there had been no signal limitations in the camera, and if it had been calibrated far beyond 5 volts, the resulting curve would have been very much the same as our real curve extrapolated beyond 4.1 volts, provided the calibration algorithm is based on radiation physics, like the Flir Systems algorithm. Of course there must be a limit to such extrapolations.

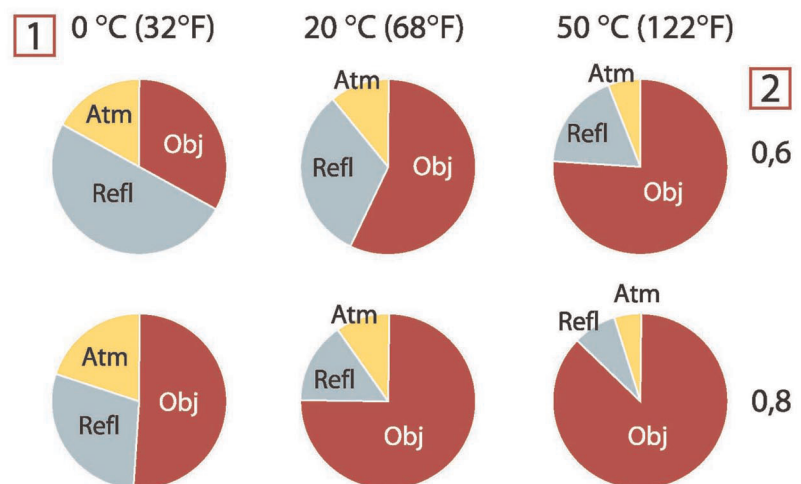

Figure 16.2 Relative magnitudes of radiation sources under varying measurement conditions (SW camera). 1: Object temperature; 2: Emittance; Obj: Object radiation; Refl: Reflected radiation; Atm: atmosphere radiation. Fixed parameters: $\tau = 0.88$; $T_{\text{refl}} = 20^{\circ}\text{C}$ ($+68^{\circ}\text{F}$); $T_{\text{atm}} = 20^{\circ}\text{C}$ ($+68^{\circ}\text{F}$).

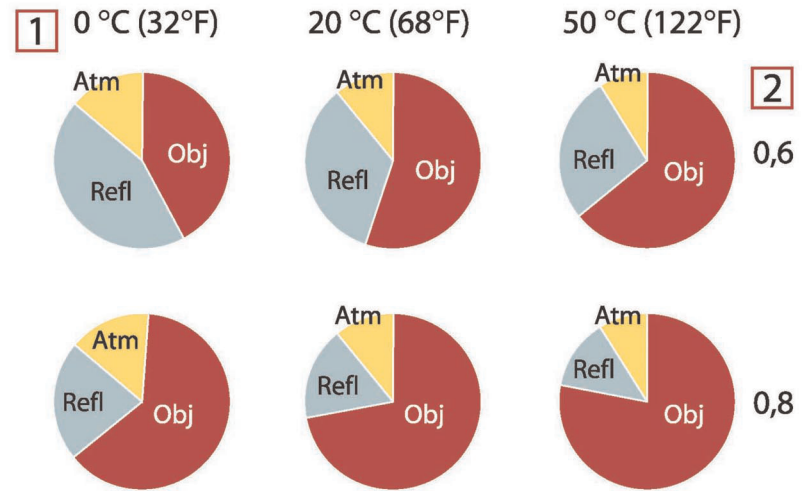

Figure 16.3 Relative magnitudes of radiation sources under varying measurement conditions (LW camera). 1: Object temperature; 2: Emittance; Obj: Object radiation; Refl: Reflected radiation; Atm: atmosphere radiation. Fixed parameters: $\tau = 0.88$; $T_{\text{refl}} = 20^\circ\text{C}$ (+68°F); $T_{\text{atm}} = 20^\circ\text{C}$ (+68°F).

This section presents a compilation of emissivity data from the infrared literature and measurements made by Flir Systems.

17.1 References

1. Mikael A. Bramson: *Infrared Radiation, A Handbook for Applications*, Plenum press, N.Y.
2. William L. Wolfe, George J. Zissis: *The Infrared Handbook*, Office of Naval Research, Department of Navy, Washington, D.C.
3. Madding, R. P.: *Thermographic Instruments and systems*. Madison, Wisconsin: University of Wisconsin – Extension, Department of Engineering and Applied Science.
4. William L. Wolfe: *Handbook of Military Infrared Technology*, Office of Naval Research, Department of Navy, Washington, D.C.
5. Jones, Smith, Probert: *External thermography of buildings...*, Proc. of the Society of Photo-Optical Instrumentation Engineers, vol.110, Industrial and Civil Applications of Infrared Technology, June 1977 London.
6. Paljak, Pettersson: *Thermography of Buildings*, Swedish Building Research Institute, Stockholm 1972.
7. Vlcek, J: *Determination of emissivity with imaging radiometers and some emissivities at $\lambda = 5 \mu\text{m}$* . Photogrammetric Engineering and Remote Sensing.
8. Kern: *Evaluation of infrared emission of clouds and ground as measured by weather satellites*, Defence Documentation Center, AD 617 417.
9. Öhman, Claes: *Emittansmätningar med AGEMA E-Box*. Teknisk rapport, AGEMA 1999. (Emittance measurements using AGEMA E-Box. Technical report, AGEMA 1999.)
10. Mattei, S., Tang-Kwor, E: *Emissivity measurements for Nextel Velvet coating 811-21 between -36°C AND 82°C* .
11. Lohrengel & Todtenhaupt (1996)
12. ITC Technical publication 32.
13. ITC Technical publication 29.

Note

The emissivity values in the table below are recorded using a shortwave (SW) camera. The values should be regarded as recommendations only and used with caution.

17.2 Tables

Table 17.1 T: Total spectrum; SW: 2–5 μm ; LW: 8–14 μm , LLW: 6.5–20 μm ; 1: Material; 2: Specification; 3: Temperature in $^{\circ}\text{C}$; 4: Spectrum; 5: Emissivity; 6: Reference

1	2	3	4	5	6
3M type 35	Vinyl electrical tape (several colors)	< 80	LW	Ca. 0.96	13
3M type 88	Black vinyl electrical tape	< 105	LW	Ca. 0.96	13
3M type 88	Black vinyl electrical tape	< 105	MW	< 0.96	13
3M type Super 33+	Black vinyl electrical tape	< 80	LW	Ca. 0.96	13
Aluminum	anodized sheet	100	T	0.55	2
Aluminum	anodized, black, dull	70	SW	0.67	9
Aluminum	anodized, black, dull	70	LW	0.95	9
Aluminum	anodized, light gray, dull	70	SW	0.61	9
Aluminum	anodized, light gray, dull	70	LW	0.97	9

Emissivity tables

Table 17.1 T: Total spectrum; SW: 2–5 μm ; LW: 8–14 μm , LLW: 6.5–20 μm ; 1: Material; 2: Specification; 3: Temperature in $^{\circ}\text{C}$; 4: Spectrum; 5: Emissivity; 6: Reference (continued)

1	2	3	4	5	6
Aluminum	as received, plate	100	T	0.09	4
Aluminum	as received, sheet	100	T	0.09	2
Aluminum	cast, blast cleaned	70	SW	0.47	9
Aluminum	cast, blast cleaned	70	LW	0.46	9
Aluminum	dipped in HNO_3 , plate	100	T	0.05	4
Aluminum	foil	27	10 μm	0.04	3
Aluminum	foil	27	3 μm	0.09	3
Aluminum	oxidized, strongly	50–500	T	0.2–0.3	1
Aluminum	polished	50–100	T	0.04–0.06	1
Aluminum	polished plate	100	T	0.05	4
Aluminum	polished, sheet	100	T	0.05	2
Aluminum	rough surface	20–50	T	0.06–0.07	1
Aluminum	roughened	27	10 μm	0.18	3
Aluminum	roughened	27	3 μm	0.28	3
Aluminum	sheet, 4 samples differently scratched	70	SW	0.05–0.08	9
Aluminum	sheet, 4 samples differently scratched	70	LW	0.03–0.06	9
Aluminum	vacuum deposited	20	T	0.04	2
Aluminum	weathered, heavily	17	SW	0.83–0.94	5
Aluminum bronze		20	T	0.60	1
Aluminum hydroxide	powder		T	0.28	1
Aluminum oxide	activated, powder		T	0.46	1
Aluminum oxide	pure, powder (alumina)		T	0.16	1
Asbestos	board	20	T	0.96	1
Asbestos	fabric		T	0.78	1
Asbestos	floor tile	35	SW	0.94	7
Asbestos	paper	40–400	T	0.93–0.95	1
Asbestos	powder		T	0.40–0.60	1
Asbestos	slate	20	T	0.96	1
Asphalt paving		4	LLW	0.967	8
Brass	dull, tarnished	20–350	T	0.22	1
Brass	oxidized	100	T	0.61	2
Brass	oxidized	70	SW	0.04–0.09	9
Brass	oxidized	70	LW	0.03–0.07	9
Brass	oxidized at 600 $^{\circ}\text{C}$	200–600	T	0.59–0.61	1
Brass	polished	200	T	0.03	1

Table 17.1 T: Total spectrum; SW: 2–5 µm; LW: 8–14 µm, LLW: 6.5–20 µm; 1: Material; 2: Specification; 3: Temperature in °C; 4: Spectrum; 5: Emissivity; 6: Reference (continued)

1	2	3	4	5	6
Brass	polished, highly	100	T	0.03	2
Brass	rubbed with 80-grit emery	20	T	0.20	2
Brass	sheet, rolled	20	T	0.06	1
Brass	sheet, worked with emery	20	T	0.2	1
Brick	alumina	17	SW	0.68	5
Brick	common	17	SW	0.86–0.81	5
Brick	Dinas silica, glazed, rough	1100	T	0.85	1
Brick	Dinas silica, refractory	1000	T	0.66	1
Brick	Dinas silica, unglazed, rough	1000	T	0.80	1
Brick	firebrick	17	SW	0.68	5
Brick	fireclay	1000	T	0.75	1
Brick	fireclay	1200	T	0.59	1
Brick	fireclay	20	T	0.85	1
Brick	masonry	35	SW	0.94	7
Brick	masonry, plastered	20	T	0.94	1
Brick	red, common	20	T	0.93	2
Brick	red, rough	20	T	0.88–0.93	1
Brick	refractory, corundum	1000	T	0.46	1
Brick	refractory, magnesite	1000–1300	T	0.38	1
Brick	refractory, strongly radiating	500–1000	T	0.8–0.9	1
Brick	refractory, weakly radiating	500–1000	T	0.65–0.75	1
Brick	silica, 95% SiO ₂	1230	T	0.66	1
Brick	sillimanite, 33% SiO ₂ , 64% Al ₂ O ₃	1500	T	0.29	1
Brick	waterproof	17	SW	0.87	5
Bronze	phosphor bronze	70	SW	0.08	9
Bronze	phosphor bronze	70	LW	0.06	9
Bronze	polished	50	T	0.1	1
Bronze	porous, rough	50–150	T	0.55	1
Bronze	powder		T	0.76–0.80	1
Carbon	candle soot	20	T	0.95	2
Carbon	charcoal powder		T	0.96	1
Carbon	graphite powder		T	0.97	1
Carbon	graphite, filed surface	20	T	0.98	2
Carbon	lampblack	20–400	T	0.95–0.97	1
Chipboard	untreated	20	SW	0.90	6

Table 17.1 T: Total spectrum; SW: 2–5 μm ; LW: 8–14 μm , LLW: 6.5–20 μm ; 1: Material; 2: Specification; 3: Temperature in $^{\circ}\text{C}$; 4: Spectrum; 5: Emissivity; 6: Reference (continued)

1	2	3	4	5	6
Chromium	polished	50	T	0.10	1
Chromium	polished	500–1000	T	0.28–0.38	1
Clay	fired	70	T	0.91	1
Cloth	black	20	T	0.98	1
Concrete		20	T	0.92	2
Concrete	dry	36	SW	0.95	7
Concrete	rough	17	SW	0.97	5
Concrete	walkway	5	LLW	0.974	8
Copper	commercial, burnished	20	T	0.07	1
Copper	electrolytic, carefully polished	80	T	0.018	1
Copper	electrolytic, polished	–34	T	0.006	4
Copper	molten	1100–1300	T	0.13–0.15	1
Copper	oxidized	50	T	0.6–0.7	1
Copper	oxidized to blackness		T	0.88	1
Copper	oxidized, black	27	T	0.78	4
Copper	oxidized, heavily	20	T	0.78	2
Copper	polished	50–100	T	0.02	1
Copper	polished	100	T	0.03	2
Copper	polished, commercial	27	T	0.03	4
Copper	polished, mechanical	22	T	0.015	4
Copper	pure, carefully prepared surface	22	T	0.008	4
Copper	scraped	27	T	0.07	4
Copper dioxide	powder		T	0.84	1
Copper oxide	red, powder		T	0.70	1
Ebonite			T	0.89	1
Emery	coarse	80	T	0.85	1
Enamel		20	T	0.9	1
Enamel	lacquer	20	T	0.85–0.95	1
Fiber board	hard, untreated	20	SW	0.85	6
Fiber board	masonite	70	SW	0.75	9
Fiber board	masonite	70	LW	0.88	9
Fiber board	particle board	70	SW	0.77	9
Fiber board	particle board	70	LW	0.89	9
Fiber board	porous, untreated	20	SW	0.85	6
Gold	polished	130	T	0.018	1
Gold	polished, carefully	200–600	T	0.02–0.03	1
Gold	polished, highly	100	T	0.02	2
Granite	polished	20	LLW	0.849	8

Table 17.1 T: Total spectrum; SW: 2–5 µm; LW: 8–14 µm, LLW: 6.5–20 µm; 1: Material; 2: Specification; 3: Temperature in °C; 4: Spectrum; 5: Emissivity; 6: Reference (continued)

1	2	3	4	5	6
Granite	rough	21	LLW	0.879	8
Granite	rough, 4 different samples	70	SW	0.95–0.97	9
Granite	rough, 4 different samples	70	LW	0.77–0.87	9
Gypsum		20	T	0.8–0.9	1
Ice: See Water					
Iron and steel	cold rolled	70	SW	0.20	9
Iron and steel	cold rolled	70	LW	0.09	9
Iron and steel	covered with red rust	20	T	0.61–0.85	1
Iron and steel	electrolytic	100	T	0.05	4
Iron and steel	electrolytic	22	T	0.05	4
Iron and steel	electrolytic	260	T	0.07	4
Iron and steel	electrolytic, carefully polished	175–225	T	0.05–0.06	1
Iron and steel	freshly worked with emery	20	T	0.24	1
Iron and steel	ground sheet	950–1100	T	0.55–0.61	1
Iron and steel	heavily rusted sheet	20	T	0.69	2
Iron and steel	hot rolled	130	T	0.60	1
Iron and steel	hot rolled	20	T	0.77	1
Iron and steel	oxidized	100	T	0.74	4
Iron and steel	oxidized	100	T	0.74	1
Iron and steel	oxidized	1227	T	0.89	4
Iron and steel	oxidized	125–525	T	0.78–0.82	1
Iron and steel	oxidized	200	T	0.79	2
Iron and steel	oxidized	200–600	T	0.80	1
Iron and steel	oxidized strongly	50	T	0.88	1
Iron and steel	oxidized strongly	500	T	0.98	1
Iron and steel	polished	100	T	0.07	2
Iron and steel	polished	400–1000	T	0.14–0.38	1
Iron and steel	polished sheet	750–1050	T	0.52–0.56	1
Iron and steel	rolled sheet	50	T	0.56	1
Iron and steel	rolled, freshly	20	T	0.24	1
Iron and steel	rough, plane surface	50	T	0.95–0.98	1
Iron and steel	rusted red, sheet	22	T	0.69	4
Iron and steel	rusted, heavily	17	SW	0.96	5
Iron and steel	rusty, red	20	T	0.69	1
Iron and steel	shiny oxide layer, sheet,	20	T	0.82	1
Iron and steel	shiny, etched	150	T	0.16	1
Iron and steel	wrought, carefully polished	40–250	T	0.28	1

Table 17.1 T: Total spectrum; SW: 2–5 μm ; LW: 8–14 μm , LLW: 6.5–20 μm ; 1: Material; 2: Specification; 3: Temperature in $^{\circ}\text{C}$; 4: Spectrum; 5: Emissivity; 6: Reference (continued)

1	2	3	4	5	6
Iron galvanized	heavily oxidized	70	SW	0.64	9
Iron galvanized	heavily oxidized	70	LW	0.85	9
Iron galvanized	sheet	92	T	0.07	4
Iron galvanized	sheet, burnished	30	T	0.23	1
Iron galvanized	sheet, oxidized	20	T	0.28	1
Iron tinned	sheet	24	T	0.064	4
Iron, cast	casting	50	T	0.81	1
Iron, cast	ingots	1000	T	0.95	1
Iron, cast	liquid	1300	T	0.28	1
Iron, cast	machined	800–1000	T	0.60–0.70	1
Iron, cast	oxidized	100	T	0.64	2
Iron, cast	oxidized	260	T	0.66	4
Iron, cast	oxidized	38	T	0.63	4
Iron, cast	oxidized	538	T	0.76	4
Iron, cast	oxidized at 600 $^{\circ}\text{C}$	200–600	T	0.64–0.78	1
Iron, cast	polished	200	T	0.21	1
Iron, cast	polished	38	T	0.21	4
Iron, cast	polished	40	T	0.21	2
Iron, cast	unworked	900–1100	T	0.87–0.95	1
Krylon Ultra-flat black 1602	Flat black	Room temperature up to 175	LW	Ca. 0.96	12
Krylon Ultra-flat black 1602	Flat black	Room temperature up to 175	MW	Ca. 0.97	12
Lacquer	3 colors sprayed on Aluminum	70	SW	0.50–0.53	9
Lacquer	3 colors sprayed on Aluminum	70	LW	0.92–0.94	9
Lacquer	Aluminum on rough surface	20	T	0.4	1
Lacquer	bakelite	80	T	0.83	1
Lacquer	black, dull	40–100	T	0.96–0.98	1
Lacquer	black, matte	100	T	0.97	2
Lacquer	black, shiny, sprayed on iron	20	T	0.87	1
Lacquer	heat-resistant	100	T	0.92	1
Lacquer	white	100	T	0.92	2
Lacquer	white	40–100	T	0.8–0.95	1
Lead	oxidized at 200 $^{\circ}\text{C}$	200	T	0.63	1
Lead	oxidized, gray	20	T	0.28	1
Lead	oxidized, gray	22	T	0.28	4
Lead	shiny	250	T	0.08	1
Lead	unoxidized, polished	100	T	0.05	4
Lead red		100	T	0.93	4
Lead red, powder		100	T	0.93	1

Table 17.1 T: Total spectrum; SW: 2–5 μm ; LW: 8–14 μm , LLW: 6.5–20 μm ; 1: Material; 2: Specification; 3: Temperature in $^{\circ}\text{C}$; 4: Spectrum; 5: Emissivity; 6: Reference (continued)

1	2	3	4	5	6
Leather	tanned		T	0.75–0.80	1
Lime			T	0.3–0.4	1
Magnesium		22	T	0.07	4
Magnesium		260	T	0.13	4
Magnesium		538	T	0.18	4
Magnesium	polished	20	T	0.07	2
Magnesium powder			T	0.86	1
Molybdenum		1500–2200	T	0.19–0.26	1
Molybdenum		600–1000	T	0.08–0.13	1
Molybdenum	filament	700–2500	T	0.1–0.3	1
Mortar		17	SW	0.87	5
Mortar	dry	36	SW	0.94	7
Nextel Velvet 811-21 Black	Flat black	–60–150	LW	> 0.97	10 and 11
Nichrome	rolled	700	T	0.25	1
Nichrome	sandblasted	700	T	0.70	1
Nichrome	wire, clean	50	T	0.65	1
Nichrome	wire, clean	500–1000	T	0.71–0.79	1
Nichrome	wire, oxidized	50–500	T	0.95–0.98	1
Nickel	bright matte	122	T	0.041	4
Nickel	commercially pure, polished	100	T	0.045	1
Nickel	commercially pure, polished	200–400	T	0.07–0.09	1
Nickel	electrolytic	22	T	0.04	4
Nickel	electrolytic	260	T	0.07	4
Nickel	electrolytic	38	T	0.06	4
Nickel	electrolytic	538	T	0.10	4
Nickel	electroplated on iron, polished	22	T	0.045	4
Nickel	electroplated on iron, unpolished	20	T	0.11–0.40	1
Nickel	electroplated on iron, unpolished	22	T	0.11	4
Nickel	electroplated, polished	20	T	0.05	2
Nickel	oxidized	1227	T	0.85	4
Nickel	oxidized	200	T	0.37	2
Nickel	oxidized	227	T	0.37	4
Nickel	oxidized at 600 $^{\circ}\text{C}$	200–600	T	0.37–0.48	1
Nickel	polished	122	T	0.045	4
Nickel	wire	200–1000	T	0.1–0.2	1
Nickel oxide		1000–1250	T	0.75–0.86	1
Nickel oxide		500–650	T	0.52–0.59	1
Oil, lubricating	0.025 mm film	20	T	0.27	2

Table 17.1 T: Total spectrum; SW: 2–5 μm ; LW: 8–14 μm , LLW: 6.5–20 μm ; 1: Material; 2: Specification; 3: Temperature in $^{\circ}\text{C}$; 4: Spectrum; 5: Emissivity; 6: Reference (continued)

1	2	3	4	5	6
Oil, lubricating	0.050 mm film	20	T	0.46	2
Oil, lubricating	0.125 mm film	20	T	0.72	2
Oil, lubricating	film on Ni base: Ni base only	20	T	0.05	2
Oil, lubricating	thick coating	20	T	0.82	2
Paint	8 different colors and qualities	70	SW	0.88–0.96	9
Paint	8 different colors and qualities	70	LW	0.92–0.94	9
Paint	Aluminum, vari- ous ages	50–100	T	0.27–0.67	1
Paint	cadmium yellow		T	0.28–0.33	1
Paint	chrome green		T	0.65–0.70	1
Paint	cobalt blue		T	0.7–0.8	1
Paint	oil	17	SW	0.87	5
Paint	oil based, aver- age of 16 colors	100	T	0.94	2
Paint	oil, black flat	20	SW	0.94	6
Paint	oil, black gloss	20	SW	0.92	6
Paint	oil, gray flat	20	SW	0.97	6
Paint	oil, gray gloss	20	SW	0.96	6
Paint	oil, various colors	100	T	0.92–0.96	1
Paint	plastic, black	20	SW	0.95	6
Paint	plastic, white	20	SW	0.84	6
Paper	4 different colors	70	SW	0.68–0.74	9
Paper	4 different colors	70	LW	0.92–0.94	9
Paper	black		T	0.90	1
Paper	black, dull		T	0.94	1
Paper	black, dull	70	SW	0.86	9
Paper	black, dull	70	LW	0.89	9
Paper	blue, dark		T	0.84	1
Paper	coated with black lacquer		T	0.93	1
Paper	green		T	0.85	1
Paper	red		T	0.76	1
Paper	white	20	T	0.7–0.9	1
Paper	white bond	20	T	0.93	2
Paper	white, 3 different glosses	70	SW	0.76–0.78	9
Paper	white, 3 different glosses	70	LW	0.88–0.90	9
Paper	yellow		T	0.72	1
Plaster		17	SW	0.86	5
Plaster	plasterboard, untreated	20	SW	0.90	6

Table 17.1 T: Total spectrum; SW: 2–5 μm ; LW: 8–14 μm , LLW: 6.5–20 μm ; 1: Material; 2: Specification; 3: Temperature in $^{\circ}\text{C}$; 4: Spectrum; 5: Emissivity; 6: Reference (continued)

1	2	3	4	5	6
Plaster	rough coat	20	T	0.91	2
Plastic	glass fibre laminate (printed circ. board)	70	SW	0.94	9
Plastic	glass fibre laminate (printed circ. board)	70	LW	0.91	9
Plastic	polyurethane isolation board	70	LW	0.55	9
Plastic	polyurethane isolation board	70	SW	0.29	9
Plastic	PVC, plastic floor, dull, structured	70	SW	0.94	9
Plastic	PVC, plastic floor, dull, structured	70	LW	0.93	9
Platinum		100	T	0.05	4
Platinum		1000–1500	T	0.14–0.18	1
Platinum		1094	T	0.18	4
Platinum		17	T	0.016	4
Platinum		22	T	0.03	4
Platinum		260	T	0.06	4
Platinum		538	T	0.10	4
Platinum	pure, polished	200–600	T	0.05–0.10	1
Platinum	ribbon	900–1100	T	0.12–0.17	1
Platinum	wire	1400	T	0.18	1
Platinum	wire	500–1000	T	0.10–0.16	1
Platinum	wire	50–200	T	0.06–0.07	1
Porcelain	glazed	20	T	0.92	1
Porcelain	white, shiny		T	0.70–0.75	1
Rubber	hard	20	T	0.95	1
Rubber	soft, gray, rough	20	T	0.95	1
Sand			T	0.60	1
Sand		20	T	0.90	2
Sandstone	polished	19	LLW	0.909	8
Sandstone	rough	19	LLW	0.935	8
Silver	polished	100	T	0.03	2
Silver	pure, polished	200–600	T	0.02–0.03	1
Skin	human	32	T	0.98	2
Slag	boiler	0–100	T	0.97–0.93	1
Slag	boiler	1400–1800	T	0.69–0.67	1
Slag	boiler	200–500	T	0.89–0.78	1
Slag	boiler	600–1200	T	0.76–0.70	1
Snow: See Water					
Soil	dry	20	T	0.92	2
Soil	saturated with water	20	T	0.95	2

Table 17.1 T: Total spectrum; SW: 2–5 µm; LW: 8–14 µm, LLW: 6.5–20 µm; 1: Material; 2: Specification; 3: Temperature in °C; 4: Spectrum; 5: Emissivity; 6: Reference (continued)

1	2	3	4	5	6
Stainless steel	alloy, 8% Ni, 18% Cr	500	T	0.35	1
Stainless steel	rolled	700	T	0.45	1
Stainless steel	sandblasted	700	T	0.70	1
Stainless steel	sheet, polished	70	SW	0.18	9
Stainless steel	sheet, polished	70	LW	0.14	9
Stainless steel	sheet, untreated, somewhat scratched	70	SW	0.30	9
Stainless steel	sheet, untreated, somewhat scratched	70	LW	0.28	9
Stainless steel	type 18-8, buffed	20	T	0.16	2
Stainless steel	type 18-8, oxidized at 800°C	60	T	0.85	2
Stucco	rough, lime	10–90	T	0.91	1
Styrofoam	insulation	37	SW	0.60	7
Tar			T	0.79–0.84	1
Tar	paper	20	T	0.91–0.93	1
Tile	glazed	17	SW	0.94	5
Tin	burnished	20–50	T	0.04–0.06	1
Tin	tin-plated sheet iron	100	T	0.07	2
Titanium	oxidized at 540°C	1000	T	0.60	1
Titanium	oxidized at 540°C	200	T	0.40	1
Titanium	oxidized at 540°C	500	T	0.50	1
Titanium	polished	1000	T	0.36	1
Titanium	polished	200	T	0.15	1
Titanium	polished	500	T	0.20	1
Tungsten		1500–2200	T	0.24–0.31	1
Tungsten		200	T	0.05	1
Tungsten		600–1000	T	0.1–0.16	1
Tungsten	filament	3300	T	0.39	1
Varnish	flat	20	SW	0.93	6
Varnish	on oak parquet floor	70	SW	0.90	9
Varnish	on oak parquet floor	70	LW	0.90–0.93	9
Wallpaper	slight pattern, light gray	20	SW	0.85	6
Wallpaper	slight pattern, red	20	SW	0.90	6
Water	distilled	20	T	0.96	2
Water	frost crystals	–10	T	0.98	2
Water	ice, covered with heavy frost	0	T	0.98	1
Water	ice, smooth	0	T	0.97	1
Water	ice, smooth	–10	T	0.96	2

Table 17.1 T: Total spectrum; SW: 2–5 μm ; LW: 8–14 μm , LLW: 6.5–20 μm ; 1: Material; 2: Specification; 3: Temperature in $^{\circ}\text{C}$; 4: Spectrum; 5: Emissivity; 6: Reference (continued)

1	2	3	4	5	6
Water	layer >0.1 mm thick	0–100	T	0.95–0.98	1
Water	snow		T	0.8	1
Water	snow	–10	T	0.85	2
Wood		17	SW	0.98	5
Wood		19	LLW	0.962	8
Wood	ground		T	0.5–0.7	1
Wood	pine, 4 different samples	70	SW	0.67–0.75	9
Wood	pine, 4 different samples	70	LW	0.81–0.89	9
Wood	planed	20	T	0.8–0.9	1
Wood	planed oak	20	T	0.90	2
Wood	planed oak	70	SW	0.77	9
Wood	planed oak	70	LW	0.88	9
Wood	plywood, smooth, dry	36	SW	0.82	7
Wood	plywood, untreated	20	SW	0.83	6
Wood	white, damp	20	T	0.7–0.8	1
Zinc	oxidized at 400 $^{\circ}\text{C}$	400	T	0.11	1
Zinc	oxidized surface	1000–1200	T	0.50–0.60	1
Zinc	polished	200–300	T	0.04–0.05	1
Zinc	sheet	50	T	0.20	1

A note on the technical production of this publication

This publication was produced using XML — the eXtensible Markup Language. For more information about XML, please visit <http://www.w3.org/XML/>

A note on the typeface used in this publication

This publication was typeset using Linotype Helvetica™ World. Helvetica™ was designed by Max Miedinger (1910–1980).

LOEF (List Of Effective Files)

T501027.xml; 7052; 2013-04-03
T505552.xml; 6839; 2013-03-18
T505551.xml; 6834; 2013-03-18
T505469.xml; 5929; 2012-10-29
T505013.xml; 5929; 2012-10-29
T505545.xml; 7022; 2013-04-02
T505547.xml; 7026; 2013-04-03
T505550.xml; 7026; 2013-04-03
T505097.xml; 5929; 2012-10-29
T505470.xml; 5935; 2012-10-29
T505012.xml; 5433; 2012-09-03
T505007.xml; 6351; 2013-01-28
T505004.xml; 5937; 2012-10-29
T505000.xml; 6040; 2012-11-09
T505005.xml; 5939; 2012-10-29
T505001.xml; 5940; 2012-10-29
T505006.xml; 5941; 2012-10-29
T505002.xml; 6915; 2013-03-25



Corporate Headquarters

Flir Systems, Inc.
27700 SW Parkway Ave.
Wilsonville, OR 97070
USA
Telephone: +1-503-498-3547

Website

<http://www.flir.com>

Customer support

<http://support.flir.com>

Publ. No.: T559828
Release: AA
Commit: 7052
Head: 7459
Language: en-US
Modified: 2013-04-03
Formatted: 2013-04-22